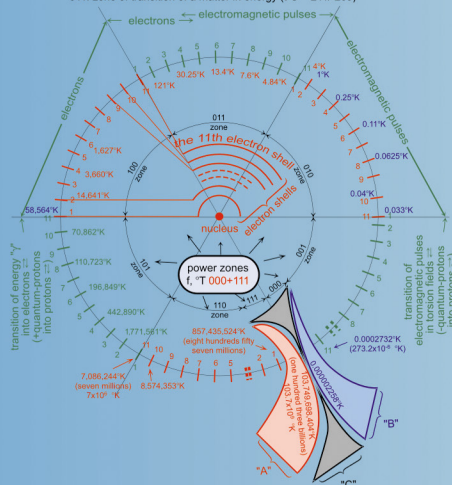

Fig. 17

${}^1_1\text{H}$ in the "121x121" matrix

A diagram illustrating conversion of one energy type into another (quantization) at each of the eleventh levels (electron shell).

011: zone of transition of a matter in energy (${}^1\text{C}=\pm 211/-269$)



N. Shlyakhtin

New in quantum physics

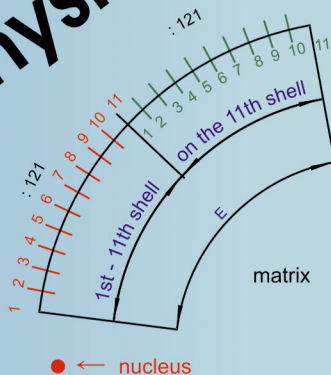

"the God does not play with bones"

or the beginning of the

"uncertainty principle" ending

NEW IN QUANTUM PHYSICS

© Nikolay Shlyakhtin, 2007

Table of contents

Introduction	3
New in quantum physics	
1. “The new approach and creation of the “single coordinates” in order to adjust interrelation between the atoms of hydrogen 1_1H , helium 4_2He and other atoms with nucleus charge z ”	13
2. Relations of electron shells of atoms with the nucleus charge equal to z with respect to electron shells of the atom of deuterium 2_1H on the scale of the “ 242×242 ” matrix and of the atom of helium 4_2He on the scale of the “ 121×121 ” matrix	28
3. The conversion of hydrogen into the “ 121×121 ” matrix. Proton, neutron. Electron, antielectron. Positron, antipositron. The energy of electron	35
4. The matter of relation of temperatures in degrees of Celsius and Kelvin on the linear scale and in the “ 121×121 ” quantization matrix for the atom of hydrogen 1_1H , as related to the energy potential E through const III = $2.32549 \cdot 10^{-4}$ eV/degree; $E = 2.32549 \cdot 10^{-4} \cdot T^0 \left(\frac{eV}{deg} \cdot \frac{deg}{1} = eV \right)$	43
5. Application of formula $E = 2.32549 \cdot 10^{-4} \cdot T^0$ for determination of resonant frequencies in a specific temperature range for “carbon – hydrogen” compounds .	47
6. The energy balance of the Universe, galaxies, planets, on the Earth (from 484^0K to 4^0K), in the deep vacuum based on the formula $E = 2.32549 \cdot 10^{-4} \cdot T$ (0K), eV, as shown in Fig. 17	53
Appendices	57-78

Introduction

On pages of the Stephen Hawking's book: "A Briefer History of Time" or theory "cutoff" is the standpoint of individual scientists for the way of how the Universe where we live is organized.

If Einstein, the greatest scientist of 20-th century, having been created the general and special theories of relativity, having received the Nobel Prize for the contribution in the quantum theory creation, would have today an opportunity to observe what is going on with his scientific heritage, the way of how his concept is interpreted on the top of the highest Olympus science, he would be mildly speaking very much surprised.

With trying "to push through" into all spheres of the physical science the Heisenberg's "uncertainty principle" (the approach of 20-th years, 19-th century, which had replaced the Newton's mechanic on the quantum one), an attempt to transform the Einstein's classical general theory of relativity in the quantum theory of gravitation, i.e., creation of the quantum theory of gravitation into which the "uncertainty principle" will be introduced, is not ceased.

To the question: "What should it be done for? - in fact, all experiments to the present moment confirm the general theory of relativity!" - We can hear the answer: "The reason, we still have not noticed any differences between the theory and observations, consists in the following: the gravitational fields which we usually know are very weak".

Such the conclusion could be formed only from the "laziness" of mind or "very weak" attempts to change or improve though something, relying on the knowledge which mankind has accumulated.

Listen what they say: "... For a while we can accept that a certain set of laws completely predetermining events for a certain supernatural essence (here, probably, they have in mind the God, the author's comment) which is capable, in

contrast to us, to observe existing state of the Universe without disturbing it. However, such models of the Universe do not represent the great interest for us, ordinary mortal men”.

And further they declare: “... It is reasonable to use a so-called principle of the “Occam’s razor” and to cutoff all theory elements which have no evident demonstrations”.

Well, my dear reader, “to cutoff”! As a result, we observe the “cutoff” of the theory which these sirs then offer to us. Well, it is a kind of an interesting approach, but hardly acceptable, I am sure, for many and many scientists.

Everyone has the right for its proper vision of the World, it is related to everyone of us, an ordinary reader. But people engaged with the science on the professional level, besides this right, are necessary to have a responsibility, while bearing their proper ideology for the public opinion, especially when the reference is fulfilled for “... the majority of scientists”.

Of course, for today the reason of all troubles in the physical science consists in absence of the theory, developed and accepted by the scientific community, which unambiguously could show the possibility with greater accuracy not only to predict but also to count energy, frequency, temperature of any microparticle in any place.

I would even say so: Available theories of such level, having place to be both in Russia and abroad, “have not yet paved the way”.

New theories are hardly settled down on the Olympus of the science, but the old ones disappear even more hardly and painfully.

It may seem, but the fact is for the last twenty years there are no any attempts in the physical science to study and establish interrelation between the atoms of hydrogen (1_1H) and helium (4_2He), no to mention the interrelation of other atoms of the periodic table, to calculate the nucleus energy balance of an atom, an electron, a neutrino. Up to now their values obtained by experimental methods are used.

Neither in manuals nor in scientific works you cannot see a clear definition what is “proton”, “neutron”, “electron”, “positron”, “neutrino”. Accordingly, there are no answers to the questions “How are they connected between each other?”, “In what frequency limits and temperatures do they exist?”, “What is the modification regularity of their energy potential?”.

Certainly, there will not be any progress in such physical vacuum (from the point of view of physics knowledge level). And to explain the microcosm and macrocosm is practically impossible. New time requires new, more modernized approaches in explanation of the processes occurring in our Universe and around us. And the science, instead of “to strain the crinkles”, shakes “a dusty bag” and gets out the “uncertainty principle” from it.

I am absolutely sure, the Heisenberg’s “uncertainty principle” and Schrödinger’s “psy-functions”, having been played the positive role in the past, are now the obstacle in a further development, both for quantum physics and for explanation questions of the World creation and formation.

In fact to the present moment such areas of the physical science as gravitation, large-scale structure of the Universe cannot be explained from the point of view of the “uncertainty principle”.

The Einstein’s general theory of relativity does not consider the quantum-mechanical uncertainty principle.

Einstein was thrice right, objecting to the quantum mechanics which have introduced an element of uncertainty and accident in the science. Einstein persistently objected to it. He had never accepted the Universe was managed by a Case and his words: “the God does not play with bones” are prophetic.

Discussions of individual scientists on the World creation and formation, in which the basis of “uncertainty principle” is put, have brought scientists so far from the truth that their conclusions, mildly speaking, can be called as doubtful.

Read popular enough, as authors by themselves mark, the book “A Briefer History of Time” from cover to cover (authors Stephen Hawking and Leonard Mlodinow, the first - known astrophysicist in the world of science, the second is the co-author, popularizer of science) and you will see up to what level of “understanding” the scientists came.

I will quote only three extracts from the final chapter of this book.

1. “... if the Universe is completely independent, and has no singularity or boundaries and can be described all by the incorporated theory, it makes to radically reconsider the role of the God as the Creator”.

Under the “incorporated theory” is meant the theory, in which during many years (even decades) the physical science tries to make the “uncertainty principle” fundamental characteristics of the Universe where we live in (the author’s comment). What is the answer to it?

- Dear sirs, the Universe where we live in, will be described by the “unified” theory, but in this theory there is no place for the “uncertainty principle”.

- In fact, the Universe has the singularity and boundaries!

- The Universe is not independent. It lives and develops under the laws of the “Cosmic Mind” (cosmic laws) which you cannot “reach” because of the “uncertainty principle”.

- It is not necessary for you, and there is no need to reconsider “the role of the God as the Creator”. To you it is simply not allowed. Indeed, if you cannot reach up to the “Cosmic Mind” even in its definition, then, you should not try to reach up to the “Superior Mind” as the God and the Creator.

But at least, do make the conclusion of what you declare: “... to reconsider the role of the God as the Creator”. The clever and thinking person, obviously feeling itself in the realities of the World today, simply note reading these words that you are ignoramuses. But in fact in readership there are a lot of unprepared but curious minds accepting information and trusting you, who wrote this, because you are a well-known

astrophysicist generally recognized in the World of science. What is going on? You speak there is no God. It is ok, although it is a pity if you made this conclusion only for you, but you are trying to impose this ideology on others.

And what about the “restless” Islamic world today, religious foundations with centuries-old even thousand-year ways of life in other countries? And what will you provide them instead of the human faith crushed by you? May be your “uncertainty principle”?!

If the concept: “the God is Creator” sickens you, just call it the “Superior Mind”, there are also lot of atheists among the readers. At least think about it, as the role and significance of the God - the Creator (the Superior Mind) will not be reconsidered all over the World, while there is a common sense among the people. And explanations to such phenomena as the Absolute, the Consciousness, the Cosmic Mind and the Superior Mind already exist for a long time but the Western science stands up against its acceptance.

In general, as I understand, to give explanations concerning the World is the lot of philosophers, or philosophers together with physicists and representatives of other directions in science. But the things are not to reach for the explanations because of the following reason. As we used to speak: “Do not put blame on your neighbor, but look at yourself”.

For your better understanding, my dear reader, I will quote one more extract from the final chapter of the book:

2. “... Until now the majority of scientists have been too much engaged with creation of new theories describing what is the Universe in order to ask a question what for”. On the other hand, people whose work is to ask what for, philosophers, could not keep up with progress of naturalistic and scientific doctrines. In the 18-th century philosophers considered all human knowledge, including natural sciences, as area of their forces applying and discussed

such questions as: whether the Universe had a beginning. However in the 19-th and 20-th centuries natural sciences have too closely mixed with technics and mathematics in order to remain popular for philosophers or somebody else, except for few specialists. Philosophers have reduced their sphere of claims so, that Wittgenstein, the most known thinker of the 20-th century, has told: “the unique problem, remained for philosophy, is the language analysis”. What decay after the great philosophy tradition from Aristotle up to Kant!”

Believe, the dear reader, a fever penetrates from such ignorant attitude of authors of the book to philosophers, and, as a whole, representatives of one science to other scientists. And in fact philosopher Wittgenstein, unfortunately, is right, but not that “Aristotles” and “Kants” “have degenerated” among philosophers as it is emphasized by the book authors and that the physical science, in particular, does not give them, philosophers, any food for thought. And really, will the philosopher respecting himself relate seriously to the so-called progress of natural sciences mixed with technics and mathematics if it is simply “soap bubbles” in the form of the Heisenberg’s “uncertainty principle” and Schrödinger’s “psy-functions”?

Aforesaid words do not mean at all that the quantum theory is incorrect in principle. Moreover, even these components of the quantum physics: both the “uncertainty principle” and “psy-functions” were necessary at the certain stage to fill “vacuum of misunderstanding” in the quantum physics. Unfortunately, this “vacuum of misunderstanding” was cultivated for so long and continues to be cultivated among students, post-graduate students, scientists, that the “vacuum” began to be shown in our heads, in our consciousness. Here one more (the last) extract from the book:

3. “... In essence, we have already reconsidered

the task of the science: this is the opening of laws, which will allow us to predict events in the boundaries set by the uncertainty principle”.

Well, dear reader, neither more nor less they (and it would be desirable to know them by name) have reconsidered the task of the science. What is it? Is it the “Black period” in the science or do these people really not understand, what they do? In any case, I think, they act hastily. If you, sirs, just a little see “the role of the science” in it, it is not worth a pin to such the science. And you will be “blaming” for a long time philosophers of the 21-st century, that they “... nobody else, except for few specialists” do not understand your science.

How to explain these sirs, that they not only themselves but even others lead to “nowhere”. Take any, I emphasize, any manual “The course of the general physics” and open the chapters: “The Nuclear physics” and “Physics of the atomic nucleus and elementary particles”. You will read in the part: the “uncertainty principle”:

- “... If an electron falls into a point nucleus, his coordinates and impulse would accept certain (zero) values, it is not compatible with the “uncertainty principle”.

In section “Radio-activity” beta-decay is explained as follows:

- “... There are three existent beta-decay varieties. In one case the nucleus undergoing transformation emits an electron, in another one - a positron, in the third case named as electronic capture (e - capture), the nucleus absorbs one electron”.

I do not know whether it is by chance or not but these two parts the “uncertainty principle” and “Radio-activity”, as a rule, in all manuals are dispersed, one in the beginning, another one in the end. Cannot it be really visible these two parts “are not gathered”? How correctly to interpret this writing in these parts by the same philosophers? Sure, an electron “does not fall” onto the nucleus it is a practice, but an electron “is absorbed” by the nucleus it is also a practice.

But if an electron can be absorbed and emitted by the

nucleus, it is (adjoins) at any moment in the same coordinates with the nucleus. In fact it is a quite sensible conclusion. The fact that Beta-decay occurs how is described in the manual is irrefutable during decades and daily proves to be true in practice. It became the axiom for physicists already for a long time with including those ones who "... have already reconsidered the task of the science ...".

And what can we do with the "uncertainty principle" which says that "... if an electron falls onto the point nucleus... it is incompatible with the uncertainty principle"? Under the theory of Beta-decay and from practice, an electron not only falls (absorbed by the nucleus) but also is emitted by the nucleus (here the concept "separation" from the nucleus suits more).

So must we do? To continue repeating this "physical mantra" (the uncertainty principle) and "to trample down"? Or is it time to reconsider something? I think it is time to put the end to the "uncertainty principle" and to write: "If an electron can have the common coordinates with the nucleus, it means that the uncertainty principle cannot be not applied in the World explanation (both the microcosm and macrocosm)".

And then, dear sirs - scientists, it is necessary to think seriously whether it is worth to waste time "... to open laws which will allow us to predict events in the boundaries set in the uncertainty principles". For all of us it is time to turn to the real science - to knowledge sources. In fact it is not casual that gravitation and large-scale structure of the Universe do not consider quantum-mechanical uncertainty principle up to now. "The God does not play with bones" - if not all but the majority of scientists really understand these Einstein's words which became classics.

Believe, sirs, while we shall not establish the order in our heads there will not be the order in our house, and let everyone understand this in his own way. For someone the "house" is an apartment, a cottage, for someone - his country and for someone - the whole Planet, the whole World. Scientists differ from each other in this attitude to their

“house”. In our country there is a lot of widely thinking scientists, whose theoretical and practical works can be “go-ahead” in the scientific world. Frequently their works in different spheres of sciences far advance results of works of other countries scientists in the similar directions. But there is no “coming out”, confirmation and recognition of these works at the world level, at least during the last decade.

We can only regret that for today the fine works of our scientists such as G.I.Shipov and A.E.Akimov (“The Theory of physical vacuum”) do not find the broad encouragement and discussion. Results of works of outstanding Soviet scientists have disappeared “in anywhere” - V.A.Lubimov, E.G.Novikov, V.Z.Nozik, E.F.Tretjakov, V.S.Kozik have made experiments still in 1975 - 1980 years as a result of which they have come to the conclusion that “... the rest mass of a neutrino is non-zero and, possibly, is within the limits from 15 to 44 (electronvolt), and, most likely, makes 35 (electronvolt) ...”.

For that moment, in 80-th years, many scientists noted that if results of these experiences proved to be true, it would necessary to make essential amendments to the existing picture of both the microcosm (i.e. the world of elementary particles) and especially macrocosm (i.e. the Universe).

And in fact their results of measurings of the neutrino rest mass, could say, are ideally true. The calculations through matrices show that the neutrino rest mass in the matrix “ 242×242 ” (for the hydrogen group) makes 16.07472 (electronvolt) and in the matrix “ 121×121 ” (for the atom of helium) – 34.9279 (electronvolt).

Compare with their conclusions: “... from 15 to 44 (electronvolt), and, most likely, 35 (electronvolt) ...”. And if those scientists got encouragement and recognition of their works in 80-th years, the question on the further application of the “uncertainty principle” would be solved at that period. And today we would already have more serious works and the better understanding of the structure of the microcosm and macrocosm.

But we are glad that today the potential of scientists in

our country and abroad is so great that the feeling, that we are really on a threshold of a “Great” discovery, wanders around us. It seems to me that it is lack of “a little”: mutual understanding, trust and respect among scientists - and these are components of dialogue.

I cannot say what is worse. Is it a published work of a scientist which even has received a negative response, or the same work but hidden under a bushel? All the scientists without exception are to begin with this question and to search its answer. The answer of this question gives the understanding “for the sake of what?” and “how?”. If many scientists have already an answer of the question “for the sake of what?”, not everyone can answer the question “how?”. And the reason of it – to make sciences bureaucratic, a fear to lose the image, criteria of graduating and retaining of an academic degree, a post – these are components of qualities not promoting the prosperity of the science. Therefore the question: “to publish?” or “to hide under a bushel?” has no a scientific unequivocal answer from the point of view of common sense of a concrete person - scientist.

But we should thank the scientists who publish their works and are opened to dialogue. Should thank for their boldness, civil position. Such people setting out their vision, their understanding of the world, are the locomotive exciting the scientific environment, they promote the mankind progress along steps of its development.

Even if I and maybe someone with me do not share Stephen Hawking's credo today, we should understand that this book and its author have given us the food for thought. Likely, this book will move many scientists not indifferent to events happening in the World to self-expression, search and reflections.

Nikolay Shlyakhtin

NEW IN QUANTUM PHYSICS

1. “The new approach and creation of the “single coordinates” in order to adjust interrelation between the atoms of hydrogen 1H , helium 4He and other atoms with charge z ”.

For the time being, many of the issues in the theory of quantum physics remain little-studied and give no sufficiently complete and logical explanation for the results obtained in practice:

- inconsistency between dependencies on temperature, frequency and wave-length;
- lack of interrelation between the atoms of hydrogen and helium, and correspondingly, between these atoms and atoms of other chemical elements from the periodic table;
- presence of rather complicated and intricate approach to the matter of superfluidity (particularly that of helium II).

The above-mentioned and many other matters, which remain theoretically unexplained today, push the scientists towards seeking for the new approaches, which would ensure complete theoretical explanation for the results obtained in practice.

One of such approaches, which (from the author’s point of view) is totally consistent with the fundamental theoretical conclusions of the founders of quantum physics, is to be presented here.

The following constants (const) are the result of the work done:

“**III**” = $2.32549 \cdot 10^{-4}$ (eV/degree) is the universal constant of variation of the potential (electronvolt) with the temperature changing by one degree (Celsius or Kelvin);

“**M**” = $562.311 \cdot 10^8$ (Hz/degree) is the universal constant of variation of the frequency (hertz) with the temperature changing by one degree (Celsius or Kelvin);

“ $T_{\text{ionization}} \text{}^1_1\text{H}$ ” = **58564⁰K** is the temperature, at which the atom of hydrogen would get ionized becoming a proton;

“ $T_{\text{ionization}} \text{}^4_2\text{He}$ ” = **31812⁰K** is the temperature of the helium atom ionization.

$$E = III \cdot T^0 = 2.32549 \cdot 10^{-4} \text{ eV/degree} \cdot T^0;$$

$$E_{\text{ionization}} \text{}^1_1\text{H} = 13.619 \text{ eV}; E_{\text{ionization}} \text{}^2_1\text{H} = 14.796 \text{ eV};$$

$$E_{\text{ionization}} \text{}^3_1\text{H} = 16.07472 \text{ eV};$$

$$E_{\text{ionization}} \text{}^3_2\text{He} = 7.10375 \text{ eV}; E_{\text{ionization}} \text{}^4_2\text{He} = 7.398 \text{ eV}.$$

The “ $2n^2$ ” constant is known from the studies of the atom presented in the course of physics. This constant allows determination of the maximum possible number of electrons on the atom n -th shell. Here, the following questions arise: is it the actual number of electrons or is it the number of quantum states of an electron (groups of electrons)? As we know, the number of electrons is different in the atoms of different elements and depends on the charge of the atomic nucleus. Thus, the atom of hydrogen has one electron, the atom of helium has two electrons, the atom of lithium has three electrons, and so on, i.e. the atom of each element has its own group of electrons. The question is whether they are quantized in groups or independently, including quantization within their groups?

In the author’s opinion (confirmed with the following calculations), quantization of electrons takes place in groups, each of which has z electrons, such group having $2n^2/z$ quantum states on the n -th shell in an atom. This rule covers all the atoms (both with the nucleus charge z equal to 1, 2, 3 ..., and those with the charge equal to 80, 92, 100, etc.) This is the first of the conclusions in the above arguments laid in the basis of the suggested new method.

Another conclusion should be the recognition of existence in real conditions of conversion of a material particle (an electron) into an electromagnetic pulse and vice versa: the electromagnetic pulse may be converted into electrons by

means of “twisting” pulse energy in torsion fields. Knowing these conditions, it is possible to break intermolecular bonds in the exothermal mode, when the process of molecular decomposition takes place not only without extra energy input, but also with the release of large amounts of internal energy of bonds. These are the above-mentioned conversions from the material state into the energetic one, which determine the properties of helium II. It is known that under certain conditions helium II becomes superfluid and acquires extremely high thermal conductivity.

Similar approaches related to the conversion of one type of energy into another also refer to the atomic nucleus - nucleons, with a single difference: conversion of an electron from the material particle into the electromagnetic pulse and vice versa takes place within the range of temperatures and frequencies available for measuring at today level of science and technology $60000^0\mathbf{K} \geq T$ (degrees) $\geq 1^0\mathbf{K}$, while conversions in nucleons take place at temperatures beyond these limits: $6 \times 10^7^0\mathbf{K} \leq T$ (degrees) $\leq 1 \times 10^{-3}^0\mathbf{K}$.

Therefore, the author has accepted two assumptions:

1. $2n^2/z$ is the number of quantum-states of an electron (groups of electrons);
2. There are conditions, under which an electron may be converted from the material particle into the electromagnetic pulse (which is explained by the so-called dualism).

To follow the argument, let us assume that for the atom of hydrogen with charge $z=1$ (1H) the number $2n^2/z$ is equal to $2n^2$. Hence, the eleventh electron shell of the atom of hydrogen has $2n^2 = 2 \cdot 11^2 = 242$ quantum-states of an electron. Yet, according to the interpretation given in courses of physics, this is just the number of electrons (quantum-states of electrons) on the eleventh shell. However, each of the eleven shells is also quantized by the energy potential in accordance with the formula $E_n = E/n^2$.

Unlike helium (4He), the atom of hydrogen (1H) has just one electron on the first shell, and accordingly, there must

be two quantum-states of an electron on the first shell of the atom of hydrogen. Yet in manuals (as well as in practical calculations) the formula $E_n = E/n^2$ is used, which is true for helium (${}^4_2\text{He}$) in the “121 × 121” matrix (see below) but not true for hydrogen, as the calculation of quantum-states for helium is $2n^2/z = 2n^2/2 = n^2$, while for hydrogen it is $2n^2/z = 2n^2/1 = 2n^2$, therefore, the formula for hydrogen should look like $E_n = E/2n^2$ – a hydrogen group ${}^1_1\text{H}$ - hydrogen; ${}^2_1\text{H}$ - deuterium; ${}^3_1\text{H}$ - tritium – in the “242 × 242” matrix (see below). In the author’s opinion, that is the reason (see the calculations below) behind the absence of dependence of λ and ν (i.e. wave-length and radiation frequency) on temperature, at which $\lambda \cdot \nu \neq c$ ($c = 3 \cdot 10^8$ m/sec).

So, from the first to the eleventh shells of the atom of hydrogen (${}^1_1\text{H}$), the number of energy quantum-states is $E_n = E/2n^2 = E/2 \cdot 11^2 = E/2 \cdot 121 = E/242$.

As a result, we have $E/242 = 242W_n$, i.e. two hundred and forty two energy quantum-states of an electron from the first to the eleventh shells, and $2n^2 = 242$ quantum-states of an electron on the eleventh shell itself.

As the whole, we have $2n^2 \times 2n^2 = 242 \times 242 = 58564$ quantum-states of an electron for the atom of hydrogen (${}^1_1\text{H}$).

With the atom of helium (${}^4_2\text{He}$), this scheme will look like $2n^2/z \times 2n^2/z = n^2 \times n^2 = 121 \times 121 = 14641$ quantum-states for a group of electrons (group of two atoms).

Therefore, $2n^2/z \times 2n^2/z$ is the number of quantum-states of electrons (group of electrons z) for any atom with charge z . Here, the first multiplier $2n^2/z$ corresponds to quantum-states of the potential from the first to the eleventh shells, and the second multiplier $2n^2/z$ corresponds to the quantum-state of an electron on the eleventh shell itself.

That is the approach to be taken for the basis for concordance of atoms of any elements from the periodic table, i.e. an effort to create the “single coordinates”. Let us define the schemes for determination of quantum-states for hydrogen

“242 × 242” and helium “121 × 121” as matrices ($2n^2/z \times 2n^2/z$ is a matrix).

These matrices of quantum-states of an electron (groups of electrons) are presented in the attached figures, where:

Fig. 1 presents the “242 × 242” matrix;

Fig. 2 presents the “121 × 121” matrix;

Fig. 3 presents the combined matrices (it can be seen from Fig.3 that the number of quantum-states of the “242 × 242” matrix is equal to 58564, which is four times bigger than the “size” or number of quantum-states of the “121 × 121” matrix; indeed, $58564 / 14641 = 4$).

There is another acceptable method allowing to the atom electron shells to be “unfolded” and presented in the arc form. Here, the matrix will correspond not to the total number of quantum-states of electrons (groups of electrons), but a two-staged quantization (where the first stage covers from the first to the eleventh shells, while the second stage refers to the eleventh shell itself). Therefore, we can transform the matrix $2n^2/z = n^2/z + n^2/z$, which will substantially simplify understanding of ongoing processes while selecting the “single coordinates” for the calculation of parameters of atoms and coordination of their characteristics. The transformed matrix (this could be both “121 × 121” and “242 × 242”) is presented in **Fig. 4**.

The most versatile atom in respect to all other atoms is the atom of helium (${}^4_2\text{He}$) with the “121 × 121” matrix. Therefore, when selecting the “single coordinates” we take the scheme of helium quantizing for the basis.

As a result of the previous arguments, we came to the conclusion that $2n^2/z$ may be presented not just as the number of electrons on the n -th shell but as $(2n^2/z)^2$, that is the number of quantum-states of an electron (groups of electrons) of the atom with charge z (see diagrams 1 and 2). $2n^2/z = n^2/z + n^2/z$ refers to the unfolded atom shells (in the arc), where double quantization is taking place. The first stage of this double process covers from the first to the eleventh shells, the second stage takes place on the eleventh shell itself (see diagram 4).

Looking ahead, it has to be said that it is during the second quantization on the eleventh shell that electrons are converted from the material state (particle) into the energetic one (electromagnetic pulse). The eleventh shell of any atom is an indicator of resonant characteristics or quantum-states of the atom. It is on the eleventh shell that conditions are created for appearance of $2mc^2$, $4mc^2$, $8mc^2$, which are to be considered after calculation of the matrix parameters. The above-mentioned formulas and constants used in practice and will be applied for calculations.

First, let us determine the cause of inconsistency between dependencies of frequency ν and wave-length λ on temperature. This will be achieved through the formulations and interpretations of the Wien's displacement law:

- frequency corresponding to the maximum value of spectral density of radiant exitance of a black body is proportional to its thermodynamic temperature;

- wave-length λ_{\max} corresponding to the maximum value of spectral density of radiant exitance of a black body is inversely proportional to its thermodynamic temperature:

$\lambda_{\max} = b/T$, where $b = 2.898 \cdot 10^{-3} \text{ m} \cdot \text{K}$ is the Wien's constant (according to the author's calculations, $b = 2.898106 \cdot 10^{-3} \text{ m} \cdot \text{K}$);

- λ_{\max} and ν_{\max} lie in different parts of the spectrum, and the values corresponding to them are **not bound** (*emphasized by the author*) by the relation $\lambda = c/\nu$.

To eliminate the last inconsistency (or to explain it) further investigations into the type of the Kirchhoff's function have been carried out.

The Rayleigh-Jeans's law matched well the data of experiments in the range of low radiation frequencies only. For higher frequencies it was clearly wrong. Impossibility to find an expression of the Kirchhoff's function, which would match the experimental data throughout the whole frequency range (from 0 to ∞), was figuratively defined as "ultraviolet catastrophe". In 1910 M. Planck succeeded in finding the type of function dependency of frequency on temperature exactly

corresponding to the experimental data, having introduced a notion of energy portions (quanta). The Planck's constant is defined as proportionality coefficient h between energy E and frequency ν : $E=h\nu$.

However, even now, making graphs of dependency of λ on temperature, and ν on temperature, according to the

Planck's formula $f(\omega, T) = \frac{\hbar\omega^3}{4\pi^2c^2} \frac{1}{\exp(\hbar\omega/kT) - 1}$ (where

frequency $\omega = 2\pi\nu$; $\hbar = h/2\pi$) and

$f(\lambda, T) = \frac{4\pi^2\hbar c^2}{\lambda^5} \frac{1}{\exp(2\pi\hbar c/kT\lambda) - 1}$, and allocating the data

in the coordinates, where the abscissa axis meets the relation $\lambda = 2\pi c/\omega$ (the values of λ and ω are matched with each other), we can see from the graph (**Fig. 5**) that frequency ω_{\max} corresponding to the maximum value of $f(\omega, T)$ **does not coincide** with $2\pi c/\lambda_{\max}$, where λ_{\max} is the wave-length corresponding to the maximum value of $f(\lambda, T)$. Answering the question of why functions (ω, T) and (λ, T) , at the same temperature, are not bound with relation $\lambda = c/\nu$, we could find a missing link of the chain, which could give answers to many questions.

So, in addition to the already made basic assumptions:

- $2n^2/z = n^2/z + n^2/z$ is a double quantization, its second stage taking place on the eleventh shell (Fig. 4);

- $(2n^2/z)^2$ is the number of quantum-states of an electron (groups of electrons) of the atom with charge z ,

$$\frac{2 \cdot 121}{1} \cdot \frac{2 \cdot 121}{1} = 242 \times 242 = 58564 \text{ - for hydrogen}$$

(1_1H),

$$\frac{2 \cdot 121}{2} \cdot \frac{2 \cdot 121}{2} = 121 \times 121 = 14641 \text{ - for helium } ({}^4_2He);$$

- the "121 × 121" matrix corresponding to helium (4_2He) is chosen as the "quantization matrix";

let us introduce two other assumptions based on the following considerations.

Introducing the “single coordinates” for all atoms (the “121 × 121” matrix), let us consider the formula determining the electron energy in the nucleus electrostatic field:

$$W_n = -\frac{1}{n^2} \frac{z^2 m_e e^4}{8h^2 \Sigma_0^2} \quad (1), \quad \text{where} \quad \frac{m_e e^4}{8h^3 \Sigma_0^2} = R \quad \text{is the}$$

Rydberg’s constant, and accordingly, the formula (1) will look like:

$$W_n = -\frac{z^2 Rh}{n^2}, \quad \text{where } R \cdot h = E_{\text{ionization}}({}^1H), \text{ const.}$$

Having transformed the obtained formula once again, we have:

$$\frac{W_n \cdot n^2}{z^2} = -Rh, \quad \text{or} \quad \frac{W_n}{z} \cdot \frac{n^2}{z} = -Rh \quad (2);$$

It is evident that in the formula (2) we presented z^2 as $z^2 = z_1 \cdot z_2$, where $z_1 = z_2$ is the nucleus charge. As we took a double-quantization matrix (from the first to the eleventh shell, and on the eleventh shell itself), let us consider more in details what is going on in the first and second cases of quantization.

A simplified double-quantization matrix is presented in **Fig.6**, where at the first stage (from the first to the eleventh shells) quantization only covers $W_n = E/n^2$, while at the eleventh shell itself it is the potential of the eleventh shell that is quantized ($W_n/121$):121; $W_1 = E_{\text{ionization}}$ is the first quantum-state within the range from the first to the eleventh shell; W_{121} is the one hundred and twenty first quantum-state within the range from the first to the eleventh shell; $W_{121}/1$ is the first quantum-state on the eleventh shell; $W_{121}/121$ is the one hundred and twenty-first quantum-state on the eleventh shell; n is the number of an electron shell (in the “242 × 242” matrix, there are 58564 such quantum-states); “121 × 121” = 14641 is the total number of quantum-states.

Then, calculations for hydrogen (1H) will look like:

$E_{\text{ionization}}({}^1H) = h \cdot \nu$, where:

$h = 4.1356 \cdot 10^{-15} \text{ eV} \cdot \text{c}$ is the Planck’s constant;

ν is frequency, with $n = 1$ $\nu = R = 3.2931193 \cdot 10^{15} \text{ sec}^{-1}$ is the Rydberg's constant;

$$E_{\text{ionization}} ({}^1_1H) = 4.1356 \cdot 10^{-15} \text{ eV} \cdot \text{sec} \cdot 3.2931193 \cdot 10^{15} \text{ sec}^{-1} = 13.619 \text{ eV}.$$

As hydrogen has 58564 quantum-states of an electron, let us determine the potential of one quantum-state. Let us designate this value as "III" (a universal constant):

$$\text{III} = 13.619 \text{ eV} : 58564 = 2.32549 \cdot 10^{-4} \text{ eV or}$$

$$\text{III} = 2.32549 \cdot 10^{-4} \text{ eV per quantum-state.}$$

Knowing that for hydrogen with $n = 1$ frequency $\nu = R = 3.2931193 \cdot 10^{15} \text{ sec}^{-1}$, let us determine the value of a single quantum-state frequency for hydrogen. Let us designate the obtained value as M (a universal constant):

$$M = 3.2931193 \cdot 10^{15} : 58564 = 562.31119 \cdot 10^8 \text{ Hz or}$$

$$M = 562,31119 \cdot 10^8 \text{ Hz per quantum-state.}$$

Knowing frequency of one hydrogen quantum-state, we can also calculate the wave-length for a single quantum-state of an electron:

$$\lambda = \frac{c}{M} = \frac{3 \cdot 10^8}{562.311 \cdot 10^8} = 0.00533512 \text{ m, or}$$

$\lambda = 5.3351 \cdot 10^{-3} \text{ m}$ (the value of displacement for the atom of hydrogen).

However, from the Wien's displacement law, the Wien's constant $b = 2.898 \cdot 10^{-3} \text{ m} \cdot \text{K}$, where this value exactly corresponds to the practical calculations.

The order of digits obtained in our calculations for hydrogen is $5.3351 \cdot 10^{-3} \text{ m}$, and the Wien's constant $b = 2.898 \cdot 10^{-3} \text{ m} \cdot \text{K}$, i.e. the difference between these two values makes it possible to suppose that the Wien's constant refers to the atom of helium (4_2He), and not to the atom of hydrogen 1_1H !

Having therefore passed to calculation of the atom of helium, let us first make the following step.

We are to recalculate the Wien's constant $b = 2.898 \cdot 10^{-3} \text{ m} \cdot \text{K}$ into frequency $\lambda \cdot T = 2,898 \cdot 10^{-3} \text{ m} \cdot {}^0\text{K}$:

$$\nu = \frac{c}{\lambda \cdot T} = \frac{3 \cdot 10^8}{2.898 \cdot 10^{-3}} = \frac{3000}{2.898} \cdot 10^8 \frac{\text{Hz}}{\text{K}} = 1035.19 \cdot 10^8 \frac{\text{Hz}}{\text{K}}$$

As helium (${}^4_2\text{He}$) has 14641 quantum-states, the maximum value of ν will be equal to:

$$1035.19 \cdot 10^8 \cdot 14641 = 15156216 \cdot 10^8$$

$$\nu_{\max} = 15156216 \cdot 10^8 \text{ Hz/}^{\circ}\text{K}.$$

Both for helium (${}^4_2\text{He}$) and hydrogen (${}^1_1\text{H}$) the maximum possible value of ν_{\max} in the “single coordinates” (in the “121 × 121” matrix) may be equal to $\nu_{\max} = R / (T \cdot n$ (quantum-states)), where $R = 3.2931193 \cdot 10^{15} \text{ sec}^{-1}$ per one quantum-state of temperature divided by one quantum-state of temperature. Then one quantum-state of temperature for helium will be equal to:

$$\frac{R}{\nu_{\max}} = \frac{3.2931193 \cdot 10^{15}}{15156216 \cdot 10^8} = \frac{3.2931193 \cdot 10^{15}}{1.5156216 \cdot 10^{15}} = 2.1728 \text{ K}.$$

Therefore, for the atom of helium (${}^4_2\text{He}$) each quantum-state (of two electrons) is assigned with 2.1728 K, whereas for hydrogen each quantum-state is assigned with 1.

Let us sum up the obtained results:

a) value of displacement for hydrogen $\lambda_1 {}^1_1\text{H} = 5.3351 \cdot 10^{-3} \text{ m}$;

value of the Wien’s displacement for helium $\lambda_2 {}^4_2\text{He} = 2.898 \cdot 10^{-3} \text{ m} \cdot ^{\circ}\text{K}$;

b) frequency of quantum-states for hydrogen $M_1 {}^1_1\text{H} = 562.311 \cdot 10^8 \text{ Hz}$;

frequency of quantum-states for helium $M_2 {}^4_2\text{He} = 1035.19 \cdot 10^8 \text{ Hz/}^{\circ}\text{K}$;

c) value of one quantum-state for hydrogen is 1;

value of one quantum-state for helium is 2.1728 $^{\circ}\text{K}$.

Having compared units of measurement for hydrogen and helium and having taken into account that the order of digits is commensurated, we may assume that these units both for hydrogen and helium may be referred to the Kelvin degree.

Then, for one quantum-state for hydrogen (1_1H), we obtain the following const:

$$III = 2.32549 \cdot 10^{-4} \text{ eV}/^0\text{K}; M = 562.31119 \cdot 10^8 \text{ Hz}/^0\text{K};$$

$$\text{One quantum-state} = 1^0\text{K}.$$

Having taken into account that one quantum-state for the atom of hydrogen is equal to 1^0K , and the total number of quantum-states for hydrogen (1_1H) is 58564, we conclude that the maximum temperature of the atom of hydrogen corresponding to the temperature of ionization will be equal to $1^0\text{K} \cdot 58564 = 58564^0\text{K}$ or

$$T_{\text{ionization}} {}^1_1H = 58564^0\text{K}.$$

For helium (4_2He) one quantum-state is equal to 2.1728^0K , and the total number of quantum-states is 14641. Correspondingly, the temperature of ionization will be equal to $2.1728^0\text{K} \cdot 14641 = 31812^0\text{K}$ or

$$T_{\text{ionization}} {}^4_2He = 31812^0\text{K}.$$

It is to be emphasized that the last electron pair of helium (the last quantum-state) has the potential of 2.1728^0K , accordingly, there are no electrons below this temperature (they are converted from the state of the material particle into the energetic state), that is the reason of helium II being superfluid. What is going on here is defined as a helium phase modification: helium I is transformed into helium II.

Based on the fact that, according to the above calculations, the last quantum-state, at which helium still has electrons, is registered at the temperature of 2.1728^0K , while below this temperature there are no electrons as such, and this temperature level matching the practically obtained temperature level, at which (below 2.1728^0K) helium becomes superfluid, we may conclude that our approach to interrelation of hydrogen and helium is true.

Moreover, this explanation of superfluidity of helium (4_2He) is the most objective and clear from the point of view of common sense: in the absence of electrons, the atom of helium becomes just a nucleus (in its material sense) and

correspondingly, it is easy to calculate how much smaller the diameter of this material nucleus has become, compared to the diameter of the atom of helium, when there are electrons even on the first shell, no to mention the third, fifth, etc. shells! Besides (which is also very important), we have obtained an explanation of why the Wien's displacement constant $b = 2.898 \cdot 10^{-3} \text{ m} \cdot \text{K}$, having good practical results, did not match the function of frequency on temperature. The reason turned out to lie in the fact that λ of displacement was practically determined for helium (${}^4_2\text{He}$), while ν of displacement was determined for hydrogen (${}^1_1\text{H}$).

Thus, we have obtained:

$$\begin{array}{rcl}
 T_{\text{ionization}} {}^1_1\text{H} = 58564^0\text{K} & \diagdown & \\
 & & 1,8409; \\
 T_{\text{ionization}} {}^4_2\text{He} = 31812^0\text{K} & \diagup & \\
 M_1 {}^1_1\text{H} = 562.311 \cdot 10^8 \text{ Hz}/^0\text{K} & \diagdown & \\
 & & 1,8409; \\
 M_2 {}^4_2\text{He} = 1035.19 \cdot 10^8 \text{ Hz}/^0\text{K} & \diagup & \\
 \lambda_{\text{displacement}} {}^1_1\text{H} = 5.3351 \cdot 10^{-3} \text{ m} \cdot ^0\text{K} & \diagdown & \\
 & & 1,8409. \\
 \lambda_{\text{displacement}} {}^4_2\text{He} = 2.898 \cdot 10^{-3} \text{ m} \cdot ^0\text{K} & \diagup &
 \end{array}$$

The relation of the parameters for hydrogen (${}^1_1\text{H}$) and helium (${}^4_2\text{He}$) temperatures, displacement constants, frequencies of quantum - states is equal to 1.8409. From this it follows that the relation between the values of the ionization energy for hydrogen (${}^1_1\text{H}$) and helium (${}^4_2\text{He}$) is also equal to the factor of 1.8409. Then, we may note:

$$E_{\text{ionization}} {}^4_2\text{He} = \frac{E_{\text{ionization}} {}^1_1\text{H}}{1.8409} = \frac{13.619}{1.8409} = 7.398\text{eV}.$$

Let us verify our theoretical computations by calculating $E_{\text{ionization}} \text{}^4_2\text{He}$ through the above const: $\mathbf{E}=\mathbf{III} \cdot \mathbf{T}^0 = 2.32549 \cdot 10^{-4} \text{ eV/degree} \cdot \mathbf{T}^0$

$$\text{III} = 2.32549 \cdot 10^{-4} \text{ eV}, T_{\text{ionization}} \text{}^4_2\text{He} = 31812^0\text{K},$$

$$E = \text{III} \cdot T = 2.32549 \cdot 10^{-4} \cdot 31812 = 7.398 \text{ eV or}$$

$$E_{\text{ionization}} \text{}^4_2\text{He} = 7.398 \text{ eV}.$$

Taking into account that the helium nucleus charge is twice as large as the hydrogen nucleus charge, $E_{\text{ionization}} \text{}^4_2\text{He}$ should also become twice as small, yet such decrease factor only equal to 1.8409 times. It is related to the fact that the atom of hydrogen has just one proton and no neutrons, while the nucleus of the atom of helium has two protons and two neutrons. Therefore, the difference $7.398 - \frac{13.619}{2} = 0.5885 \text{ eV}$ is explained by the presence of bond of two additional neutrons in the nucleus of the atom of helium.

Let us apply this fact for establishing interrelations between the atoms of hydrogen and its isotopes: deuterium $\text{}^2_1\text{H}$ and tritium $\text{}^3_1\text{H}$, as well as relation between helium $\text{}^4_2\text{He}$ and its isotope $\text{}^3_2\text{He}$.

Knowing $E_{\text{ionization}} \text{}^4_2\text{He}$, we may proceed to a nucleus with charge $z = 1$ (i.e. hydrogen) and make a clear assumption that for the isotope of hydrogen – deuterium - $\text{}^2_1\text{H}$, which has one proton and one neutron, the potential $E_{\text{ionization}} \text{}^2_1\text{H}$ will make two potentials $E_{\text{ionization}} \text{}^4_2\text{He}$, as these atoms are absolutely symmetrical in terms of composition of their nuclei: deuterium $\text{}^2_1\text{H}$ has one proton and one neutron, helium $\text{}^4_2\text{He}$ has two protons and two neutrons. Accordingly, $E_{\text{ionization}} \text{}^2_1\text{H} = E_{\text{ionization}} \text{}^4_2\text{He} \cdot 2 = \mathbf{14.796 \text{ eV}}$ or

$$E_{\text{ionization}} \text{}^2_1\text{H} = 14.796 \text{ eV}.$$

Let us now compare $E_{\text{ionization}} \text{}^1_1\text{H}$ (hydrogen) and $E_{\text{ionization}} \text{}^2_1\text{H}$ (deuterium):

$$\begin{array}{l}
 E_{\text{ionization}} \text{ } {}^1_1\text{H} = 13.619 \text{ eV} \\
 E_{\text{ionization}} \text{ } {}^2_1\text{H} = \mathbf{14.796 \text{ eV}}
 \end{array}
 \left. \vphantom{\begin{array}{l} E_{\text{ionization}} \text{ } {}^1_1\text{H} \\ E_{\text{ionization}} \text{ } {}^2_1\text{H} \end{array}} \right\} \Delta E_{\text{ionization}} = \mathbf{1.177 \text{ eV}}.$$

The only difference between the atom of hydrogen ${}^1_1\text{H}$ and the atom of deuterium ${}^2_1\text{H}$ lies in the presence of an additional neutron in the atom of deuterium. Accordingly, one neutron of the nucleus with charge $z = 1$ will give an increase of the potential compared to $E_{\text{ionization}} \text{ } {}^1_1\text{H}$ of hydrogen equal to $\frac{1.177 \cdot 100\%}{13.619} = 8.64234\%$.

We may suppose that in the nucleus with charge $z = 2$ two neutrons will increase the potential by 8.64234% (compared to the potential of $\frac{E_{\text{ionization}} \text{ } {}^1_1\text{H}}{z}$ or $\frac{13.613}{2} = 6.8095 \text{ eV}$). Let us try to verify this conclusion:

$$\mathbf{6.8095 \text{ eV} + 8.64234\% = 7.398 \text{ eV}}.$$

This approach may be applied to any nucleus with charge z , however it has to be considered, that the reference to the potential is determined through $E_{\text{ionization}} \text{ } {}^1_1\text{H} / z$, and the number of neutrons, which will give an increment to the potential 8.64234%, corresponds to the atom number of charge z !

Let us make calculation for another hydrogen isotope - tritium ${}^3_1\text{H}$.

We are to calculate its $E_{\text{ionization}}$:

Knowing $E_{\text{ionization}}$ of deuterium - $E_{\text{ionization}} \text{ } {}^2_1\text{H} = \mathbf{14.796 \text{ eV}}$, we only have to increase this potential by 8.64234% and obtain $E_{\text{ionization}} \text{ } {}^3_1\text{H}$ (tritium):

$$E_{\text{ionization}} \text{ } {}^3_1\text{H} = E_{\text{ionization}} \text{ } {}^2_1\text{H} + 8.64234\% = 14.796 \text{ eV} + 8.64234\% = \mathbf{16.07472 \text{ eV}}.$$

It is quite probable that deuterium (its nucleus comprising one proton and one neutron) may capture another

neutron, as the weight of the deuterium nucleus is almost twice as much as the weight of a neutron.

However, we cannot exclude a case, when two neutrons are simultaneously captured by the atom of hydrogen (1_1H). In this case, a tritium isotope may be formed, yet its potential will be different:

$$E_{\text{ionization}} {}^3_1H = E_{\text{ionization}} {}^1_1H + (8.64234\%) \cdot 2 = 13.619 \text{ eV} + 17.284647\% = \mathbf{15.973 \text{ eV}}.$$

$E_{\text{ionization}} {}^3_1H = 16.07472 \text{ eV}$ is the first isotope of tritium.

$E_{\text{ionization}} {}^3_1H = 15.973 \text{ eV}$ is the second isotope of tritium.

Exactly the same approach should be taken for the isotope of helium 3_2He . Its formation is possible through capture of one neutron by two protons: ${}^2_2He + {}^1_0n = {}^3_2He$,

$$\text{where } E_{\text{ionization}} {}^3_2He = \frac{E_{\text{ionization}} {}^1_1H}{2} + \frac{8.64234\%}{2} = \mathbf{6.8095 \text{ eV}} \\ + \mathbf{4.32117\%} = \mathbf{7.10375 \text{ eV}}.$$

$$E_{\text{ionization}} {}^3_2He = 7.10375 \text{ eV}.$$

2. Relations of electron shells of atoms with the nucleus charge equal to z with respect to electron shells of the atom of deuterium 2_1H on the scale of the “242 × 242” matrix and of the atom of helium 4_2He on the scale of the “121 × 121” matrix.

As was mentioned above, hydrogen is not “symmetrical” to helium corresponding to the “121 × 121” matrix. Therefore, the basis of the hydrogen group “242 × 242” matrix will be constituted by hydrogen isotope 2_1H , its parameters being absolutely symmetrical to the parameters of helium, and accordingly, there will be an absolute interrelation between helium 4_2He matrix (“121 × 121”) and deuterium 2_1H matrix (“242 × 242”).

$E_{\text{ionization } 1} {}^2_1H$ of deuterium is equal to 14.796 eV. Hence, the last quantum-state from the first to the eleventh shell will have the potential equal to $14.796 \text{ eV} / 242 = 0.0611405 \text{ eV}$.

$E_{\text{ionization } 2} {}^4_2He$ of helium is equal to 7.398 eV. Hence, the last quantum-state the first to the eleventh shell will have the potential equal to $7.398 \text{ eV} / 121 = 0.0611405 \text{ eV}$.

Let us analyze the formula, which makes it possible to determine the energy of an electron in the electrostatic field of the nucleus for the “121 × 121” matrix:

$$W_n = - \frac{z^2 Rh}{n^2}; Rh = \text{const} = E_{\text{ionization } 1} {}^1_1H .$$

What is z^2/n^2 in the above formula?

It may be noticed that with $z = n$, $z^2/n^2 = 1$. Accordingly, W_n will be always equal to the same value of $E_{\text{ionization}}$ of the basic element of the matrix or correspond to the potential of the first quantum state in the base matrix divided on z (nucleus charge):

Z=1: In the “242 × 242” matrix – to deuterium 2_1H
($E_{\text{ionization}} {}^2_1H = 14.796 \text{ eV}$);

Z=2: In the “121 × 121” matrix – to helium 4_2He
($E_{\text{ionization}} {}^4_2He = 7.398 \text{ eV}$).

It is known that z is the nucleus charge. As we consider relation between the atoms electron shells, n is the number of an electron shell, while the potential present on the last electron shell may be found in the following way: $W_n = E_{\text{ionization}}/n^2$, i.e. the smallest value of the potential on the eleventh shell is 121 times smaller than $E_{\text{ionization}}$ (in the “242 × 242” matrix there are $2n^2$ quantum-states of an electron on the eleventh shell, or $2 \cdot 11^2 = 242$ quantum-states. In the “121 × 121” matrix there will be 121 such quantum-states, and further on we are to consider the formula for the “121 × 121” matrix). Then we conclude that $1/121 E_{\text{ionization}}$ on the eleventh shell is also distributed among 121 quantum-states.

Therefore, we have $121 \cdot 121$ or 121^2 . If in the formula $W_n = - \frac{z^2 Rh}{n^2}$, n^2 will not only mean “the squared number of electron shell” (yet, it is also quantized the energy state, though for shells), but “the squared state” (of electron), i.e. 121 quantum-states, we are to obtain very interesting results, which by no means conflict with the theoretical arguments.

Thus, based on these considerations, we may present the electron shell as a matrix, where (or on which) the energy is quantized not only by shells, but by quantum-states of an electron (groups of electrons), see **Fig.7**.

We may suppose that the periodic table is not completed, and it may well have element 121 (which is characterized by antigravity properties, when the nucleus acquires a proton-neutron equivalent, a new state - see below).

Then, with $z = 121$ and $n = 121$ (and that is the potential of $E_{\text{ionization}}/121$ or the energy potential of the eleventh electron shell), we may observe that the eleventh shell of the atom with charge $z = 121$ will take the place of the first shell of the basic

atom in the “ 121×121 ” matrix, i.e. the first shell of the atom of helium ${}^4_2\text{He}$, and the last sublevel of the eleventh shell of the atom with charge $z = 121$ will take place of $W_n = E_{\text{ionization}}/121$, i.e. the eleventh shell of the atom of helium ${}^4_2\text{He}$ (see **Fig. 8**).

It has to be emphasized that the schematic presentation corresponds to the relation between electron shells of atoms with charge z and the atom of hydrogen, though the text says about relation between the shells in the “ 121×121 ” matrix and the atom of helium ${}^4_2\text{He}$. This is not an error of having converted hydrogen ${}^1_1\text{H}$ from the “ 242×242 ” matrix into the “ 121×121 ” matrix (see below), this was done to create a kind of “symmetry” between the atoms of all elements of the periodic table, we have transformed hydrogen in such a way that in the “ 121×121 ” matrix it gets converted from H_1 into H_2 (or ${}^2_1\text{H}$), and its electron shells in the “ 121×121 ” matrix totally coincide with arrangement of the helium ${}^4_2\text{He}$ electron shells (relative to the nucleus). That is the “price” we had to pay for creation of the single system of calculations for atoms, yet we imply that the constants (const), which we earlier obtained for hydrogen, are universal and may be used both in the “ 121×121 ” matrix, and in the “ 242×242 ” matrix:

$$\text{III} = 2.32549 \cdot 10^{-4} \text{ eV/degree};$$

$$\text{M} = 562.311 \cdot 10^8 \text{ Hz/degree.}$$

Therefore, in the “ 121×121 ” matrix, the first and the second quantum-states of an electron of the atom of hydrogen are still located on the first electron shell, just as the first quantum-state of the atom of helium is located on the first electron shell. And as locations of the first electron shells for helium and hydrogen are matched through scaling, schematic presentation of variation (displacement) of similar shells of atoms with charge z relative to the shells of the atom of hydrogen is also true and clear for understanding.

Therefore, we may conclude that the matrix (see **Fig. 9**) where with hydrogen (hydrogen isotope deuterium ${}^2_1\text{H}$)

converted into the “121 × 121” matrix (helium matrix), $E_{\text{ionization}} \text{ } ^4_2\text{He} = 7.398 \text{ eV}$ is taken for the basis of $E_{\text{ionization}}$) corresponds to the quantization of:

- the eleventh shell of the atom of hydrogen in the “121 × 121” matrix with the quantum-state (value)

$$\frac{E_{\text{ionization}} \text{ } ^4_2\text{He}}{121} \bullet Z = \frac{7.398\text{eV}}{121} \bullet Z = 0.0611405 \text{ eV} \cdot Z;$$

- the eleventh subshell of the eleventh shell of the atom with charge z relative to the eleventh subshell of the atom of hydrogen with the value (quantum-state) equal to:

$$\frac{W_{121}}{121} \bullet Z = \frac{0.0611405}{121} \bullet Z = 0.000505293 \text{ eV} \cdot Z$$

Let us return to analysis of Fig.8. The nucleus with charge $z = 121$ with a totally filled electron shell is in a state, which corresponds to the quantum-state of the nucleus. Here, we may observe both antigravity properties of the atom with charge $z = 121$, and transition of the nucleus itself into another energy state: from the proton-neutron state into a new type (new state). I.e., a nucleus, as well as an electron, should have such a state, in which one energy type becomes converted into another energy type (another state).

The nucleus with charge $z = 121$ most likely belongs to the atom, any further change of which is related to change in the nucleus, i.e. quantization of the nucleus will necessarily take place.

Let us consider more in detail quantization with the potential equal to 0.0611405 eV . We are to designate this quantum-state as $W_{\text{quant}} = 0.0611405 \text{ eV}$ and express this potential through $\text{III} = 2.232549 \cdot 10^{-4} \text{ eV/degree}$. We shall have:

$$\frac{W_{\text{quant}}}{\text{III}} = \frac{0.0611405\text{eV}}{2.32549\text{eV} / \text{deg}} = \frac{611.405}{2.32549} \text{ deg} = 262.914\text{K}$$

(We take Kelvin degrees for the basic unit of temperature, as all the calculations are only made in Kelvin degrees).

Let us designate the obtained value as $T_{\text{quant}} = 262.914^0\text{K}$.

We had two values for the quantum shells:

$$W_{\text{quant}} = 0.0611405 \text{ eV};$$

$$T_{\text{quant}} = 262.914^0\text{K};$$

For quantization of the eleventh shell:

$$\frac{W_{\text{quant}}}{121} = \frac{0.0611405\text{eV}}{121} = 0.000505293\text{eV};$$

$$\frac{T_{\text{quant}}}{121} = \frac{262.914\text{K}}{121} = 2.17285\text{K};$$

(in the “ 121×121 ” matrix, the temperature of 2.17285^0K corresponds to the last electron quantum-state of the atom of helium ${}^4_2\text{He}$, after which (at the temperature below 2.17285^0K), beginning with 2.17^0K , helium changes its properties and is transformed into the state of type II (helium II), when it is superfluid and superconductive).

As we convert all the atoms into the “single coordinates”:

for helium ${}^4_2\text{He}$ - in the “ 121×121 ” matrix;

for deuterium ${}^2_1\text{H}$ - in the “ 242×242 ” matrix,

then W_{quant} and T_{quant} will be taken as the basis for calculation of displacement of the electron shells **for other atoms** as well. Here, it has to be taken into account that the quantum-state of the nucleus with charge z will be z times as large as W_{quant} and T_{quant} .

Let us apply this method for calculation of any element from the periodic table, taking out an element, which is the most common and widely used in practice, to compare our theoretical calculations to practical results.

The characteristic most cited in manuals is that of mercury, its nucleus having charge $z = 80$.

$$W_{\text{quant}}(z80) = 0.0611405 \text{ eV} \cdot 80 = 4.891 \text{ eV}.$$

In the 121×121 coordinates (for the atom of helium ${}^4_2\text{He}$) mercury will have the number of quantized states equal to:

$121 / 80 = 1.5125$, which will be equal to potential being:

$4.891 \text{ eV} \cdot 1.5125 = 7.39763$, i.e. close to the energy of helium ionization.

However in the “ 242×242 ” coordinates (of hydrogen, and more precisely of the hydrogen isotope deuterium 2_1H) the number of quantum-states for mercury will be equal to: $242 / 80 = 3.025$, i.e. there will be three whole states for 4.891 eV. Hence, the resonance (quantized) states for mercury in the “ 242×242 ” coordinates will be:

The first one – 4.891 eV;

The second one – $4.891 \text{ eV} \cdot 2 = 9.782 \text{ eV}$;

The third one – $4.891 \text{ eV} \cdot 3 = 14.673 \text{ eV}$.

The total result with the quantization factor being 3.025, we have:

$4.891 \text{ eV} \cdot 3.025 = 14.795 \dots \text{ eV}$, or the energy of ionization of the atom of hydrogen isotope (deuterium 2_1H).

Next, we are to apply the same technique to determine through T_{quant} the quantization temperature, to be further used to find the resonant frequency and its corresponding to wave-length λ through $\text{const } M = 562.311 \cdot 10^8 \text{ Hz}/^\circ\text{K}$.

$$T_{\text{quant}}(z80) = 262.914^\circ\text{K} \cdot 80 = 21033.12^\circ\text{K}.$$

$$F_{\text{quant}}(z80) = T_{\text{quant}}(z80) \cdot M = 21033.12^\circ\text{K} \cdot 562.311 \cdot 10^8 \text{ Hz}/^\circ\text{K} = 11827154.74 \cdot 10^8 \text{ Hz}.$$

Let us determine wave-length λ (z80):

$$\lambda = \frac{c}{F} = \frac{3 \cdot 10^8 \text{ m/sec}}{11827154.74 \cdot 10^8 \text{ sec}^{-1}} = 2536.535 \cdot 10^{-10} \text{ m} = 2536.535 \text{ \AA}$$

We are now to check the obtained results to those already known from manuals with reference to practical data.

Potentials of the resonant values of the energy levels show exact matching: 4.891 eV; 9.782 eV; 14.673 eV.

The wave-length for the first quantum-state of mercury with 4.891 eV:

$\lambda(z80) = 2536.535 \overset{0}{\text{Å}}$, whereas in books and manuals on physics this value is $2536.5 \overset{0}{\text{Å}}$.

Thus, the results of calculations coincide, which means that the conclusions made about displacement of electron shells of atoms with charge z with respect to the atom of helium ${}^4_2\text{He}$ (the “ 121×121 ” matrix) and the atom of hydrogen isotope – deuterium ${}^2_1\text{H}$ (the “ 242×242 ” matrix), are true.

The continuous spectrum corresponding to quantized states of frequencies is determined for the “ 121×121 ” matrix:

$$\lambda_{\text{spectrum}} = \frac{c}{R/^{\circ}\text{K}} : T_{\text{quant}} \overset{2}{1}\text{H} \text{ (deuterium), where:}$$

$$T_{\text{quant}} \overset{2}{1}\text{H} \text{ in the “}121 \times 121\text{” matrix} = 262.914^{\circ}\text{K} \cdot 2 = 525.828^{\circ}\text{K};$$

$$R/^{\circ}\text{K} = 3.2831193 \cdot 10^{15} \text{ (sec}^{-1}/^{\circ}\text{K);}$$

$$c = 3 \cdot 10^8 \text{ m/sec, then:}$$

$$\lambda_{\text{spectrum}} = \frac{3 \cdot 10^8}{3.2931183 \cdot 10^{15} \cdot 525.828} = 1.732486... \overset{0}{\text{Å}}.$$

3. The conversion of hydrogen into the “121 × 121” matrix. Proton, neutron. Electron, antielectron. Positron, antipositron. The energy of electron.

The conversion of hydrogen 1_1H from the “242 × 242” matrix into the “121 × 121” matrix is not a “mechanical” compression of the electron shells of hydrogen into the coordinates of the electron shells of the atom of helium 4_2He . Such concept would be wrong.

“The nature of universe” is ingenious in its essence, and at the same time, logical enough to be understood.

That is why what the “121 × 121” matrix contains is not just the atom of hydrogen 1_1H , but two atoms, i.e. the coupled atom of hydrogen (two protons and two electrons).

But the way of how they are laid in the “121 × 121” matrix in respect to each other and what they are converted in will be considered in this very part.

If compressed in a mechanical (mathematical) sense, the atom of hydrogen would give us 2_2H in the “121 × 121” matrix with $E_{\text{ionization}} = E_{\text{ionization}} {}^1_1H / 2 = 6.8095 \text{ eV}$. In fact, we shall have in the “121 × 121” matrix the coupled atom of hydrogen, which does not only have common electron shells with helium 4_2He (the eleventh shell of the atom of hydrogen 1_1H in the “242 × 242” matrix is coincided with the first shell of the atom of helium 4_2He in the “121 × 121” matrix), but also $E_{\text{ionization}} = E_{\text{ionization}} {}^4_2He = 7.398 \text{ eV}$.

Why and how can it happen? It will be shown below that to answer this question means to be able to answer a number of other questions. What is the electron, and what is the positron, what is the antielectron and antipositron, what makes them different? What is the proton, and what is the neutron, what makes them different? What is the energy of

electron in the “ 121×121 ” matrix and in the “ 242×242 ” matrix? The conditions of formation of the energy of electron $/2m_e c^2 /$, $/4m_e c^2 /$, $/8m_e c^2 /$.

In the “ 242×242 ” matrix we have coupled protons, where the magnetic poles are longitudinally coincided with each other and laid along with the gravitational field (see **Fig. A**). When a coupled proton in the “ 242×242 ” matrix transits into an excited state (transition of an electron from the first to the eleventh shell), proton P2 is turned relatively to the axis “O” with the transition of its magnetic poles by 180° . In this case proton P2 does not take place after proton P1 with longitudinally coincided magnetic poles but nearby, with across located proton P1, and magnetic poles of proton P2 are turned out relatively to the gravitational field by 180° (see **Fig. B**). In this case the electron e2 is rotating around P2 nucleus but inverse (counterclockwise) and magnetic poles of the electron e2 are displaced by 180° relatively to the electron e1.

The greatness of nature of the universe is in the fact that the basic unit of its structure is the proton (neutron), while all the rest is that is going on around this basic material particle (proton).

A proton is the particle with its internal magnetic field lying along with the direction of the neutrino motion (see **Fig. C**)

The dispute of what makes the difference between the proton and neutron was a subject of heated arguments. *Today it appears very probable that the basis of the neutron is the proton with magnetic poles displaced by 180°* . It means that the neutron having positron rotating around is the atom of hydrogen mirroring, where the “electron” is rotating in the opposite direction (see Fig. C).

An electron is the particle with its internal magnetic field directed to the neutrino motion (from low-temperature zone to high-temperature zone), clockwising (in the direction of neutrino motion - view A, fig. C-V) around *proton* nucleus and having negative potential (Figs. C-I, C-V, C-VI).

A *positron* is the particle (the electron with magnetic poles displaced by 180°) rotating counterclockwise (in the direction of neutrino motion - view B, fig. C-VIII) around *neutron* nucleus and having positive potential (Figs. C-I, C-VIII, C-IX). The internal magnetic field of positron is directed to the antineutrino motion (or in the opposite direction of neutrino motion).

An *antielectron* is the electron rotating counterclockwise around *proton* nucleus (Fig. C-VII), if to see at an angle of 90° to the direction of neutrino motion (view D, fig. C-VII) – zone of 262.914^0K and higher.

An *antipositron* is the positron rotating counterclockwise around *neutron* nucleus (Fig. C-X), if to see at an angle of 90° to the direction of neutrino motion (view D, fig. C-X) – zone of 262.914^0K and lower.

It is important to note the direction of electron (antielectron) and positron (antipositron) rotation clockwise or counterclockwise, fully depends in what temperature zone there is a nucleon (proton or neutron) around which a particle is rotating, (if to see at an angle of 90° to the direction of neutrino motion: from right to left).

That is the temperature (appropriate frequency characteristic of the nucleon nucleus) in the “ 121×121 ” matrix for hydrogen (${}^1_1\text{H}$) - 484^0K and for helium (${}^4_2\text{He}$) – 262.914^0K is a “border-line” where the energies of neutrino and antineutrino are balanced (see Fig. C-XI). In the “ 121×121 ” matrix in point 484^0K for hydrogen (${}^1_1\text{H}$) and 262.914^0K for helium frequency is equal for both.

This temperature corresponds to the energy of electron on the eleventh shell of an atom in the “ 121×121 ” matrix, where the energies between the electron and antielectron, positron and antipositron, neutrino and antineutrino are balanced.

Simultaneous appearance of these parameters (characteristics) of the nucleon and electron (positron) is the base of low-temperature nuclear synthesis of light nuclei which

is possible at the synchronous passing of nuclear electromagnetic resonance and electronic paramagnetic resonance at their consistent characteristics (temperature and frequency).

In the “ 121×121 ” matrix it would be correct to define the range of temperatures from 262.914^0K for helium (484^0K for hydrogen) and lower as the “electron-proton” zone and the range of temperatures from 262.914^0K for helium (484^0K for hydrogen) and higher as the “positron-neutron” zone (see Fig. C-XI).

In the “ 121×121 ” matrix *the neutrino* affecting on a free neutron in the “electron-proton” zone converts neutron into proton (in average per 15.8 minutes).

“Neutrino” and “antineutrino” in the direction of its movement, each taken separately, are rotating clockwise.

Neutrino is formed in the low-temperature zone and antineutrino – in the high-temperature zone.

When they meet, they create oncoming directions (opposite directions) of twisting or untwisting, which at the certain conditions (frequency and temperature) make for creation of material particles - proton, neutron, electron, positron, antielectron, antipositron, etc.

The range of these frequencies and temperatures we’ll consider in the next chapters of the work. For now we just mark the following, that frequencies and temperatures between neutrino (antineutrino), electron (positron), proton (neutron) are correlated as $1:10^3:10^6$.

That is the condition of energy balance “neutrino” (“antineutrino”) with nuclear electromagnetic resonance and electron paramagnetic resonance.

In the “ 121×121 ” matrix we shall have the coupled atom of hydrogen. Let’s not hurry up to call it ^2H or H_2 as it would be wrong.

The scheme of the bond linking two atoms of hydrogen in the “ 121×121 ” matrix on the first shell (in unexcited state of the atoms) is well known: a paired shell having a shape of eight is being formed around two atoms (protons), see **Fig. D**,

where the sign of * marks an orbit of an electron and antielectron in the place of twisting of the “eight”, in points 4-4'. Farther on along the orbit, they are arranged symmetrically: 1-1'; 2-2'; 3-3', i.e. with each turn, electron and antielectron meet in the 4-4' position. This is due to the fact that two electrons cannot be simultaneously found on the orbit of the same nucleus (for a nucleus with charge $z = 1$). There is an important and determinative difference between two atoms of hydrogen located nearby and two atoms linked with an “eight-shaped” orbit. That is the peculiarity (difference), which is to be taken into account.

The formation of deuterium from nothing from two protons in the “ 121×121 ” matrix occurs with the help of smooth (according to the atom excitement) “untwisting” of “eight-shaped” orbit into a circle. In this case until tenth, - eleventh shell the axis of magnetic poles of proton P2 (or P1) is turned by 180^0 in respect to proton P1 (P2) with the following conversion on the eleventh shell of the turned proton into neutron with positron “emission”. When magnetic poles of proton P2 are being turned, the rotating direction of antielectron “e2” around the nucleus is also changed and it is transformed into antipositron. As a result, antipositron of nucleus 2 and positron “emitted” by nucleus 2 is annihilated. The nuclear electromagnetic resonance occurs, which helps the nuclei to be reunified and the nucleus 2_1H to be formed with the rest electron “e1” of nucleus 1 at the time synchronization with electronic paramagnetic resonance.

Therefore, we have one “proton-electron” 1_1H and one “neutron”. Having combined them we obtained ${}^1_1H + {}^1_0n = {}^2_1H$ or deuterium. For deuterium 2_1H in the “ 242×242 ” matrix $E_{\text{ionization}} = 14.796 \text{ eV}$, and in the “ 121×121 ” matrix $E_{\text{ionization}, {}^2_1H} = 14.796 \text{ eV} / 2 = 7.398 \text{ eV}$. That is why the hydrogen group is “represented” in the “ 121×121 ” matrix by deuterium 2_1H , being (which is very important!) symmetrical in

its structure (proton-neutron) with respect to the atom of helium ${}^4_2\text{He}$ (two protons, two neutrons).

There is an erroneous assumption often taken in manuals (as well as in some theoretical calculations), according to which, in the state presented in Fig. D, two coupled atoms (two nucleons) have just two electrons on the electron eight-shaped shell. It is not correct. If we pay attention we will see the electron (electrons) rotating around nucleus 1 (proton) in the same direction (clockwise) and around nucleus 2 – counterclockwise (positron or antielectron – in dependence on nucleus 2 whether the nucleus is neutron or proton).

Meanwhile, the electron and positron (if nucleus 2 is a neutron) constantly pass from the orbit of one nucleus to the orbit of another one, alternately rotating in the positive (clockwise) and negative (counterclockwise) directions. That is what is named the electron-positron pair, which in unexcited state of the coupled atoms on the first shell in the “ 121×121 ” matrix is totally balanced and keeps the “Rydberg’s const” for both nucleus with charge z and nuclei with charges $2Z$, $3Z$,... $80Z$, etc. (i.e. for all atoms with pre-coupled state, when interconnection “fusion” of nuclei is not finished).

It is to be kept in mind if the coupled proton in the process of its formation in the “ 242×242 ” matrix transits into the state of deuterium (${}^2_1\text{H}$), it also transits into the “ 121×121 ” matrix as the formed atom of isotope of hydrogen – deuterium, beginning from the first electron shell.

If in the “ 242×242 ” matrix the energy of nuclear electromagnetic resonance is not sufficient for the nuclei reunion, the coupled nucleon transits into the “ 121×121 ” matrix in the state showed in the Figure B: i.e. the proton-electron and neutron-positron are unified with “eight-shaped” orbit. So the twisting process of “eight-shaped” orbit started in the “ 242×242 ” matrix according to the scheme “eight” – “ellipse”, is finished on the “circle” phase on the first shell of the “ 121×121 ” matrix.

Meanwhile electrons (positrons) are rotated on the shared orbit, see **Fig. E**, and in this case in the head direction as compared with the pair formed from nothing in the “121 × 121” matrix.

The electron and positron both at the expense of quantization (synchronization) while rotating on the same shell in the head direction follow their location (the electron relatively to the positron): 1-1'; 2-2'; 3-3'.

The positron emitted by the nucleus 2 is annihilated with the electron of the nucleus 1.

The annihilation of the positron and electron duplicates (in comparison with the electron-antielectron or positron-antipositron annihilation) the energy of gamma radiation; it helps the nuclei (neutron and positron) to be already reunified on the first electron shell of the “121 × 121” matrix.

In this case positron e2 having transited to the orbit of the nucleus 1 becomes antielectron (positron) and continues its rotation around the coupled nucleus as the positron (antielectron). The positron (antielectron) is kept on the shell, because the formation (“fusion”) of the deuterium nucleus is started in the “242 × 242” matrix and finished on the first shell of the “121 × 121” matrix in the temperature zone greatly exceeding 262.914 ⁰K (positron-neutron zone)-see Fig. C-XII.

At the same time when the coupled atom transits, the process of “fusion” is not happened yet, for example, from the tenth shell in the “242 × 242” matrix to the first shell of this matrix, the inverse process takes place – not untwisting of “eight-shaped orbit” but twisting and unification of the electron orbit in the inverted sequence. In this case the axis of twisting (see Fig. B) is the axis “O-S” or “O-S' ”. As a result, we have a coupled atom with (z1 + z2) charge with two coupled electrons (positrons), as electrons and positrons are rotating in pair in the same direction at the orbits displacement relatively to the central point “O” (see Fig. A). If the rotation occurs around nuclei-protons clockwise, it is a proton pair, if the rotation occurs around nuclei-neutrons counterclockwise, it is a neutron pair.

The direction, in which the orbits will be reunified relative to axis "O" (whether point S will pass into point S', or point S' will pass into point S), is determined by a number of factors. It is a matter of principle, as it eventually determines the answer to the crucial question whether we shall have a proton pair or a neutron one. Correspondingly, the pairs to be obtained as a result (a proton or a neutron one) make a basis for construction (formation) of the atom of helium ${}^4_2\text{He}$, which consists of two protons and two neutrons etc., for nuclei with a charge equal to the "even number" z.

The calculation and the value of the energy of "electron" in the "121 × 121" matrix - see Fig. C-XII.

4. The matter of relation of temperatures in degrees of Celsius and Kelvin on the linear scale and in the “121 × 121” quantization matrix for the atom of hydrogen 1H , as related to the energy potential E through const III = $2.32549 \cdot 10^{-4}$ eV/degree; $E = 2.32549 \cdot 10^{-4} \cdot$

$$T^0 \left(\frac{eV}{\text{deg}} \cdot \frac{\text{deg}}{1} = eV \right)$$

In everyday life, we constantly use the temperature scale in Celsius degrees. The ratio between temperatures in Celsius and Kelvin degrees is well-known: the difference between the values of the same measurement of state of a body in 0K and 0C will be equal to 273, i.e. $273^0K = 0^0C$, $0^0K = -273^0C$, etc. Relation between these temperatures (with the difference equal to 273) on the linear scale is presented in **Fig. 10**. As the Celsius scale is the most widely used, let us take the temperature presentation in Celsius degrees for the basis. The only (yet, very important) addition for further reasoning presented in Fig. 10 is the relation of temperatures in 0C and 0K through const III = $2.32549 \cdot 10^{-4}$ eV/degree to the energy potential, namely to $E_{\text{ionization}}^1H = 13.619$ eV.

Having made a Celsius degree the basic unit of calculation, we have taken into account that negative temperatures have a negative energy level of ionization. As a result, within the range between 0^0C and -273^0C , E varies from 0.0000000 to -0.0634859 eV, while within the range between 0^0C to 58291^0C ($58564 - 273 = 58291$), E varies from 0.0000000 to 13.5555 eV. Note that $|+E_{\text{max}}| = 13.55555$ eV, $|-E_{\text{min}}| = 0.0634859$ eV, as a result, $E = |-E| + |+E| = 13.619$ eV. Then

$$E (^0C) = 2.32549 \cdot 10^{-4} \cdot ^0C; E (^0K) = 2.32549 \cdot 10^{-4} \cdot (^0C + 273).$$

If we are to introduce the single coordinates for the temperature range as well (in Celsius degrees), conversion of calculation results from Kelvin into Celsius degrees will be fulfilled according to the following relation:

$${}^{\circ}\text{C} = {}^{\circ}\text{K} - 273;$$

$${}^{\circ}\text{K} = 273 + {}^{\circ}\text{C},$$

i.e., the values of Kelvin degrees are converted into Celsius degrees.

Then calculation of the potential corresponding to a specific temperature range (both in Celsius degrees and in Kelvin degrees through ${}^{\circ}\text{C}$) will be performed by means of the following formulas:

$$E ({}^{\circ}\text{C}) = 2.32549 \cdot 10^{-4} \cdot {}^{\circ}\text{C};$$

$$E ({}^{\circ}\text{K}) = 2.32549 \cdot 10^{-4} \cdot ({}^{\circ}\text{C} + 273).$$

It is crucial to pay attention to the fact that using these formulas we can determine the energy potential for negative temperatures in Celsius degrees, however, we cannot determine frequency through a negative potential, as frequency cannot be negative in principle: it is either present (positive) or absent (equal to zero). That is why it is very important to remember that, when proceeding to calculation of frequencies through $\text{const } M = 562.311 \text{ Hz/degree}$, it is necessary to apply the formula in the scale of Kelvin degrees or $(273 + {}^{\circ}\text{C})$, i.e. the correct calculation of frequencies may only be obtained with the following formulas:

$$f = 562.311 \cdot 10^8 \cdot T ({}^{\circ}\text{K}), \text{ Hz};$$

$$f = 562.311 \cdot 10^8 \cdot (273 + {}^{\circ}\text{C}), \text{ Hz}.$$

It is due to the fact that quantization of frequencies in the “ 121×121 ” matrix (in particular, for hydrogen) is only performed within the positive range of the potential E and temperatures T .

Having converted $E_{\text{ionization}} \text{ } {}^1_1\text{H}$ from the “Kelvin degree” range into ${}^{\circ}\text{C}$, we shall have $13.619 \text{ eV} - (273 \cdot 2.23549 \cdot 10^{-4} \text{ eV})$. Then

$$E_{\text{ionization}} \text{ } {}^1_1\text{H} ({}^{\circ}\text{C}) = 13.5555 \text{ eV}.$$

Having converted $T_{\text{ionization}} \text{ } ^1_1\text{H}$ from the “Kelvin degree” range into $^{\circ}\text{C}$, we shall have $58564^{\circ}\text{K} - 273 = 58291^{\circ}\text{C}$. Then

$$T_{\text{ionization}} \text{ } ^1_1\text{H} (^{\circ}\text{C}) = 58291^{\circ}\text{C}.$$

Next (see **Fig. 11**), where quantization of the energy levels for $^{\circ}\text{C}$ is conventionally presented in the following way:

1. corresponds to the energy level from 58291°C to 481.74°C or from 13.5555 eV to 0.112029 eV ;
2. corresponds to the energy level from 481.74°C to 3.98°C or from 0.112029 eV to 0.000925859 eV ;
3. corresponds to the energy level from 0 to -273°C or from 0.0000000 eV to -0.0634859 eV ,

let us make a parallel of quantization in the same scale (in the “ 121×121 ” matrix) of temperatures in $^{\circ}\text{K}$ and $^{\circ}\text{C}$, and note that **between the linear scale (dependency) of these temperatures and the scale of quantum-states on electron shells of the atom (in particular, that of hydrogen ^1_1H) there is a very significant difference, which has never before been taken into account in theory or in practice** (see **Fig. 12**).

Therefore, from the above-mentioned values of temperatures, as well as from (Figs. 11 and 12) we can make sure that during quantization by quantum-states of the atom (of hydrogen), negative temperatures ($^{\circ}\text{C}$) are not quantized. That is why, doing research in laboratory conditions, with the $^{\circ}\text{C}$ scale applied, it is necessary (determining frequencies) to introduce an offset for recalculation of temperatures in Kelvin degrees: $^{\circ}\text{K} = 273 + ^{\circ}\text{C}$, or it is necessary to add an offset to the obtained value of frequency: $(562.311 \cdot 10^8 \cdot 273) \text{ Hz}$, i.e., to add the above value. Such a correction will give the actual (practical) value of frequency.

On the eleventh subshell of the eleventh shell of the atom of hydrogen, we can see the value of the first quantum-state in the “ 121×121 ” matrix, equal to 4°K .

As was shown above, in the “121 × 121” matrix, temperatures of ionization between hydrogen 1_1H and helium 4_2He are related as:

$$\frac{T_{\text{ionization}}({}^1_1H)}{T_{\text{ionization}}({}^4_2He)} = 1.8409.$$

It is exactly in the same way that temperatures of the same quantum-states should be related:

$$\frac{4K({}^1_1H)}{2.17285K({}^4_2He)} = 1.8409.$$

Thus we can confirm once again that our arguments are true in what concerns the absence of quantization on the shells of atoms of negative temperatures and necessity (while measuring temperatures in 0C) to introduce an offset for determination of the actual frequency at:

$$(562.311 \cdot 10^8 \cdot 273) \text{ Hz} = 153.511 \cdot 10^8 \text{ Hz}.$$

Thus, to determine the energy potential through the value of temperature, we have the following formulas:

$$\text{in Celsius degrees: } \mathbf{E} = 2.32549 \cdot 10^{-4} \cdot {}^0C, \text{ eV}, 0 \leq {}^0C \leq 0;$$

$$\text{in Kelvin degrees: } \mathbf{E} = 2.32549 \cdot 10^{-4} \cdot {}^0K, \text{ eV}, 0 \leq {}^0K.$$

To determine frequency through the value of temperature, we have the following formulas:

$$\text{in Celsius degrees: } \mathbf{F} = 562.311 \cdot 10^8 \cdot (273 + {}^0C), \text{ Hz}, 0 \leq {}^0C \leq 0;$$

$$\text{in Kelvin degrees: } \mathbf{F} = 562.311 \cdot 10^8 \cdot {}^0K, \text{ Hz}, 0 \leq {}^0K.$$

The constant values:

$$\mathbf{III} = 2.32549 \cdot 10^{-4} \text{ eV/degree}, \mathbf{M} = 562.311 \cdot 10^8 \text{ Hz/degree}$$

are the universal const, as they have the same values both for $1{}^0C$, and for $1{}^0K$. That is why, their more correct unit would be “per one degree”, regardless of which degree is used that of Celsius or Kelvin.

5. Application of formula $E = 2.32549 \cdot 10^{-4} \cdot T^0$ for determination of resonant frequencies in a specific temperature range for “carbon – hydrogen” compounds.

In a carbon-hydrogen mixture, the prevailing compounds are “C – C” and “C – H”. To change chemical-physical properties of oil, the latter should be influenced upon. As the rule, such influence is produced by means of heating a hydrocarbon mixture (oil) and its fractionation.

But what is the temperature range, in which it would be possible to obtain the maximum effect? And what else should be done to raise the efficiency of acting upon oil, to increase the output of light oil products (diesel, kerosene, benzene fractions).

As it is known from practice, the principal reserve is acting upon heavy molecules within the range of temperatures from 350⁰C to 500⁰C and higher (to make these molecules disintegrate into lighter ones, which brings about increase of the output of light oil products). In practice, oil-processing enterprises use an expensive technique (multiple vacuum distillation).

However, there is a more efficient method, which does not require expensive installations and allows obtaining up to 70% light oil products (of the supplied amount of oil) with just one atmospheric column used.

The essence of this method lies in the knowledge of behavior of hydrogen atoms at resonant frequencies (temperatures), when (with minimum energy input “from outside”) the “C – H” bonds are broken. As a result, the number of light molecules is increased, which gives an increase of the output of light oil products.

So, to affect heavy molecules in the temperature range above 350⁰C, we use the resonant characteristic of hydrogen.

Taking hydrogen 1_1H for the basis, in the “121 × 121” matrix we shall have:

charge and weight are six times as big as those of hydrogen 1_1H , and, correspondingly, it will define the maximum constituent of equilibrium radiation.

As the temperature of ionization of hydrogen ($T_{\text{ionization}}({}^1_1H)$) is equal to $58564^0\text{K} \cdot 13.619 \text{ eV} / (2.32549 \cdot 10^{-4} \text{ eV/degree})$, all other atoms with charge z (sum of oscillators) will have the temperature of equilibrium radiation on the first own electron shell in the “ 121×121 ” matrix z times lower.

For carbon ${}^{12}_6C$, $z = 6$, therefore the temperature on the first shell of the atom of carbon (in the scale of the matrix of hydrogen) will be six times lower than $T_{\text{ionization}}({}^1_1H)$.

To proceed from ${}^0\text{K}$ to ${}^0\text{C}$, let us apply the approach $T_{\text{ionization}}({}^0\text{C}) = T_{\text{ionization}}({}^0\text{K}) - 273$ (see above), then $T_{\text{ionization}}({}^1_1H({}^0\text{C})) = 58564^0\text{K} - 273 = 58291^0\text{C}$.

As ${}^{12}_6C$ has charge $z = 6$, $T_{\text{ionization}}({}^0\text{C})$ of the atom of carbon, with $n = 1$ (when the atom is unexcited) will be equal to:

$$T_{\text{ionization}}({}^{12}_6C({}^0\text{C})) = 58291^0\text{C} / 6 = 9715^0\text{C}.$$

According to the theory of the state of thermal equilibrium and equilibrium thermal radiation, if a charge (number of oscillators) increases with a factor equal to κ , $\frac{z = 6}{z = 1} = \kappa = 6$,

based on the formula $E = h \cdot \nu$, frequency ν should also increase with a factor of κ (as h – Planck’s constant has a fixed value).

At the same time, $\nu = R / n^2$, where R is the Rydberg’s constant, which is also fixed. Correspondingly, to make frequency increase with a factor of κ (compared to hydrogen 1_1H , $\kappa = z$ times), the number of n^2 (the number of an electron shell) should become κ or z as low (that is another variant confirming that the adopted approach to quantization (displacement) of electron shells is true).

Therefore, for the atom of carbon ${}^{12}_6C$, the resonant frequency corresponding to the resonant frequency of the atom

of hydrogen in the scale of the “121 × 121” matrix will be on the shell (in the quantum-state) $n^2 / 2 = 121 / 6 = 20.166\dots$. We have taken $n^2 = 121$, i.e. the resonant frequency of the atom of hydrogen will be found on the eleventh shell, or on the first sublevel of the eleventh shell ($W_{121} = E_{\text{ionization}} / 121$).

As we know, n^2 / z is the number of quantum-states ($20.166\dots \cdot 481.74^0\text{C} = 9715^0\text{C}$), while the square root of n^2 / z is the number of shell (from the first shell to the eleventh shell). Hence, for the atom of carbon ${}^{12}_6\text{C}$ n will be equal to:

$$n = \sqrt{\frac{n^2}{z}} = \sqrt{20.166\dots} = 4.49.$$

However, the number of a shell may only be integer, correspondingly, resonant temperatures for carbon ${}^{12}_6\text{C}$ in the “121 × 121” matrix will be on integer numbers to 4.49, i.e. 4 and 5: $n_{\text{resonance } 1}=4$, $n_{\text{resonance } 2}=5$.

In the formula of permissible values of the internal energy of the atom $E_n = -\frac{m_e e^4 z^2}{2\hbar^2 n^2}$ (with $n=1, 2, 3 \dots 11$) the author have applied the approach which uses the “single coordinates”: $z^2 = z_1 \cdot z_2$ ($z_1 = z_2$), where z_1 is used with $T_{\text{ionization } 1} H / z$, and z_2 – with n^2 / z . I.e. z_1 is used for the state of thermal equilibrium, and z_2 is used for equilibrium thermal radiation.

Let us calculate temperatures for $n = 4$ and $n = 5$ of the atom of carbon:

$$T_4 (^0\text{C}) \text{ for } {}^{12}_6\text{C} = 9715 / n^2 = 9715 / 16 = 607.2^0\text{C};$$

$$T_5 (^0\text{C}) \text{ for } {}^{12}_6\text{C} = 9715 / n^2 = 9715 / 25 = 388.6^0\text{C}.$$

Here, the resonant temperature is calculated as follows:

$$T_{\text{resonance } 1} {}^{12}_6\text{C} = 9715 / 20.166\dots = 481.74^0\text{C}.$$

However, this resonant temperature (481.74^0C) does not fall to an integer number of the electron shell (4.49), therefore, it will only appear (be enabled) due to the external factors, rather than the atom of carbon itself. This will be the very case, when we shall excite the C – H bond through the resonant

constituent of hydrogen, acting upon it (481.74⁰C). This $T_{\text{resonance}}$ is used in the invention to achieve an increase of the output of light oil products.

So, what the result can we get with $n = 4$ and $n = 5$?

$$T_4 = 607.2^{\circ}\text{C}; T_5 = 388.6^{\circ}\text{C}.$$

However, we have to determine the range of temperatures for the C – H bond; knowing that the nucleus charge and weight of hydrogen ${}^1_1\text{H}$ are six times smaller than those of carbon ${}^{12}_6\text{C}$, let us determine the percentage ratio between these numbers from the relation $z_{{}^1_1\text{H}} / z_{{}^{12}_6\text{C}} = 1 / 6$.

Since we have two oscillators taken together, temperature T , which is common for the equilibrium state and equilibrium radiation for ${}^{12}_6\text{C}$ will be changed (decreased) in the C – H bond by $(1 / 6) \cdot 100\% = 16.66\%$ and the following temperature range will be formed:

1. $T_{4\text{ max}} = 607.2^{\circ}\text{C};$
 $T_{4\text{ min}} = 607.2^{\circ}\text{C} - 16.6\% = 506^{\circ}\text{C};$
2. $T_{5\text{ max}} = 388.6^{\circ}\text{C};$
 $T_{5\text{ min}} = 388.6^{\circ}\text{C} - 16.6\% = 323.9^{\circ}\text{C}.$

It can be seen from these calculations, that they are based on the above-mentioned materials.

To make the reasoning more illustrative, and to compare the obtained results to the practical ones, **Fig. 15** and **Fig. 16** are supplemented presenting an oil diagram.

When acting upon the hydrocarbon mixture through ${}^1_1\text{H}$, we have not zone A (see Fig. 15), i.e. the zone of endothermic effect, which is constantly present in the unexcited mixture or cracking zone, but zone B (see Fig. 16), i.e. the zone of exothermal effect arising in the hydrocarbon mixture after the latter has been affected through hydrogen ${}^1_1\text{H}$, made in the laboratory conditions with an instrument, and showing the relation between the oil weight and its temperature. Resonant temperature ranges of oil (which match almost exactly the above-obtained calculated results) can be clearly seen in the diagram.

Deviations are common, but they are not very significant and are characterized by oil quality (its purity), i.e. content of sulfur, paraffin, asphalt-tar substances, etc.

A specimen under investigation was heated up to 700 °C, therefore the calculated temperatures are presented in the graph in an illustrative and complete way (throughout the whole temperature range).

6. The energy balance of the Universe, galaxies, planets, on the Earth (from 484⁰K to 4⁰K), in the deep vacuum based on the formula $E = 2.32549 \cdot 10^{-4} \cdot T(^0\text{K})$, eV, as shown in Fig. 17.

Let us sum up the above-said (see also **Fig. 17**):

1. The temperatures under consideration lie within the range from $2.258 \cdot 10^{-6} \text{ } ^0\text{K}$ to $103.7 \cdot 10^9 \text{ } ^0\text{K}$.

2. The temperature of absolute zero equal to 0.00000 ... K does not exist, as there is always a finite, yet small value (infinitesimal).

3. The entire range of temperatures under consideration comprises eight zones designated as follows:

000 - from 0.000002258 ⁰K to 0.0002732 ⁰K;

001 - from 0.0002732 ⁰K to 0.033 ⁰K;

010 - from 0.033 ⁰K to 4 ⁰K;

011 - from 4 ⁰K to 484 ⁰K;

100 - from 484 ⁰K to 58,564 ⁰K;

101 - from 58,564 ⁰K to 7,086,244 ⁰K;

110 - from 7,086,244 ⁰K to 857,435,524 ⁰K;

111 - from 857,435,524 ⁰K to 103,749,698,404 ⁰K.

4. Zones “000” and “111” are special zones, their energies collapse, when colliding, releasing the energy level even higher than the one found in zone “111”, i.e., as the author has suggested, this may be the condition of formation of the so-called “black holes”.

5. Of the remaining zones “001”÷”110” (“001”; “010”; “011”; “100”; “101”; “110”), those ending in 1 (including “111”) are of a special interest.

These zones are interesting due to the fact they are “zones of transition of one type of the energy into another one”. Thus, e.g., zone “011”, being the eleventh range (the eleventh electron shell of the atom) within the temperature range from 58,564⁰K to 4⁰K, ensures transition of the material

particle of the electron into non-material “electromagnetic pulse”. In other words, it is in this zone that transition of matter into the energy (material state) is taking place.

That is why in zone “011” within the range of temperatures from 484^0K to 4^0K electrons have properties of both particles and waves.

There are four such “zones of transition of one type of the energy into another one”. Each of them has a numerical expression of the zone number ending in 1: “001” $\rightarrow 0.000273^0\text{K} \div 0.033^0\text{K}$; “011” $\rightarrow 4^0\text{K} \div 484^0\text{K}$; “101” $\rightarrow 58,564^0\text{K} \div 7,086,244^0\text{K}$; “111” $\rightarrow 857,435,324^0\text{K} \div 103,749,698,404^0\text{K}$.

6. All the four “zones of transition of one type of the energy into another one” are at the same time the eleventh sub-ranges, each in its temperature range:

“001” – within the range $0.0002732^0\text{K} \div 4^0\text{K}$;

“011” – $4^0\text{K} \div 58,564^0\text{K}$;

“101” – $58,564^0\text{K} \div 857,435,324^0\text{K}$;

“111” – $857,435,324^0\text{K} \div 103,749,698,404^0\text{K}$.

The main peculiarity of these zones is in the fact that they are the only quantized zones (each in its temperature range), i.e. their temperature is also redistributed depending on $1 / n^2$ in the “ 121×121 ” matrix, within their corresponding temperature ranges, e.g. in the range from $58,564^0\text{K}$ to 4^0K there are eleven levels (eleven electron shells). The energy level of each electron shell is determined by $E_{\text{ionization}} / n^2$, and it is only on the eleventh shell that $E_{11} = E_{\text{ionization}} / 11^2 = 13.619 \text{ eV} / 121 = 0.112554 \text{ eV}$ (here, we consider a proton in the “ 121×121 ” matrix as an independent element, i.e. the atom of hydrogen, and take $E_{\text{ionization}}$ for hydrogen – 13.619 eV) is also redistributed (quantized) according to the formula E_{11} / n^2 , where n^2 is the number of sublevels on the eleventh level (in the “ 121×121 ” matrix). That is why the temperature range in the “zone of transition of one type of the energy into another one” is so sharply differentiated.

7. In the temperature range, according to Fig. 17:

a) zones “100”; “011” (from $58,564^0\text{K}$ to 4^0K): there are atoms consisting of a nucleus and electron shells;

б) zones “110”; “101”; “010”; “001”: the basis of nucleus is formed by a “plus quantum-proton” from $58,564^0\text{K}$ to $857,435,324^0\text{K}$, and “minus quantum-proton” from 0.0002732^0K to 4^0K ;

в) zones “000” and “111” are zones of the energies, interaction of which brings about “black holes”. In other words, an unusually high density of the energy in terms of both temperature and radiation frequency (zone “111”) as well as the energy of deep vacuum (superweak torsion fields, superlow frequencies, temperatures close to zero and the temperature $\rightarrow 0$) – zone “000”, when collapsing, make the basis of formation of “black holes” superdense matter (clot of energy);

A) – zone of an extremely high frequency of radiated energy, high density;

B) – superlow frequency, deep vacuum;

C) – formation of “black holes” – meeting (colliding), two types of the energy A and B collapse, i.e. are compressed with power and speed sufficient for a “black hole” to be formed.

It is quite possible that the quantum-state $273.2 \cdot 10^{-6}^0\text{K}$ in the “ 121×121 ” matrix (or one quantum-state $17.075 \cdot 10^{-6}^0\text{K}$ in the “ 242×242 ” matrix) is in fact the so-called neutrino (antineutrino).

So, zones “001” and “110” are the zones of “neutrino” and “antineutrino”.

Appendices

Fig. 1

Matrix of quantum states "242x242"

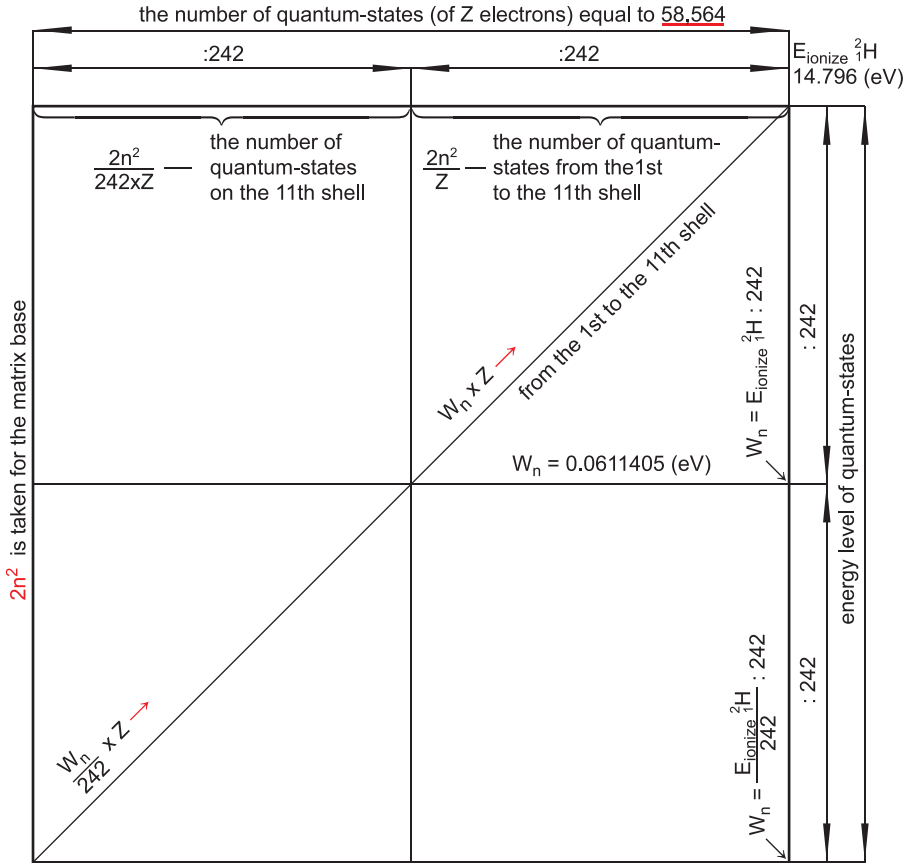

Fig. 2

Matrix of quantum states "121x121"

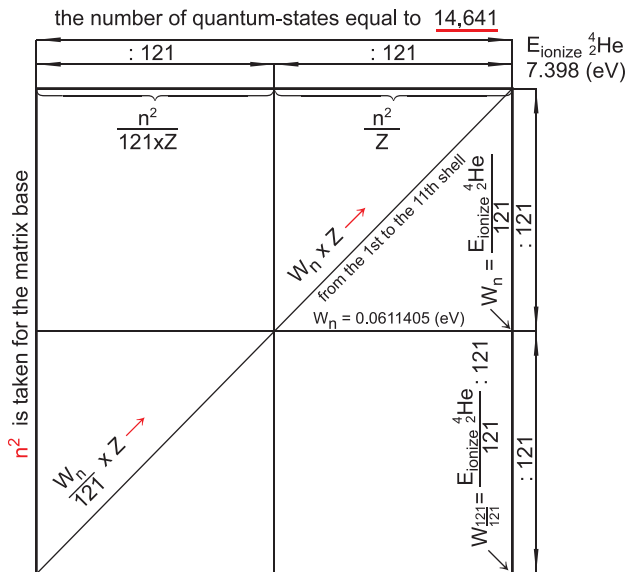
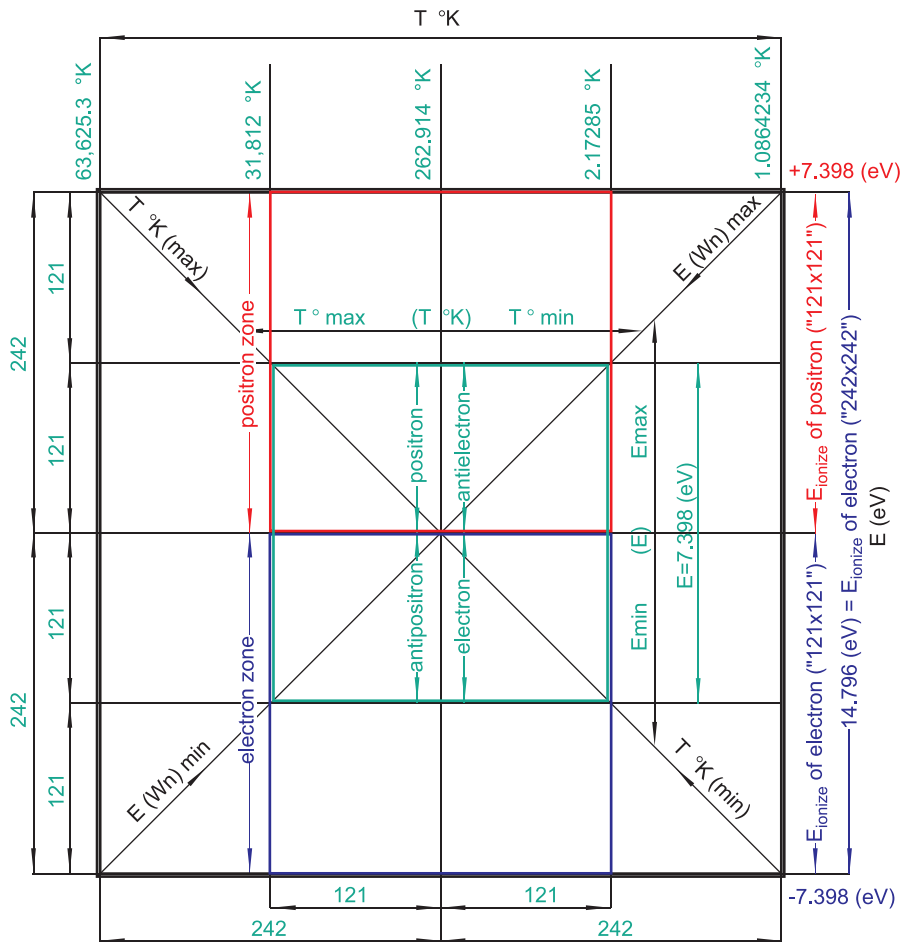

Fig. 3

"242x242" and "121x121" matrices coincidence.



- ==== - electron zone in "242x242" matrix
- ==== - electron zone in "121x121" matrix
- ==== - positron zone in "121x121" matrix
- ==== - coincided positron and electron zones in "121x121" matrix

Fig. 4

Matrix of unfolded atom shells ("121x121" for a helium atom ${}^4_2\text{He}$)

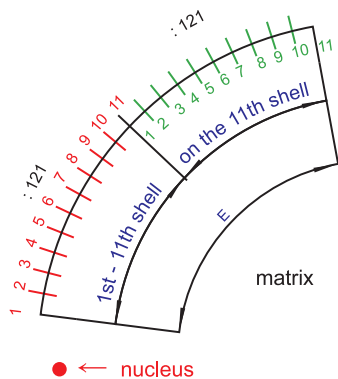

Helium atom (${}^4_2\text{He}$) is the most universal atom in respect to others. His matrix is "121x121". So, choosing the "single coordinates", the scheme of helium quantization is taken for the basis.

Fig. 5

Graphs of functions (λ, T) and (ω, T) are made for the temperature of 5000 °K

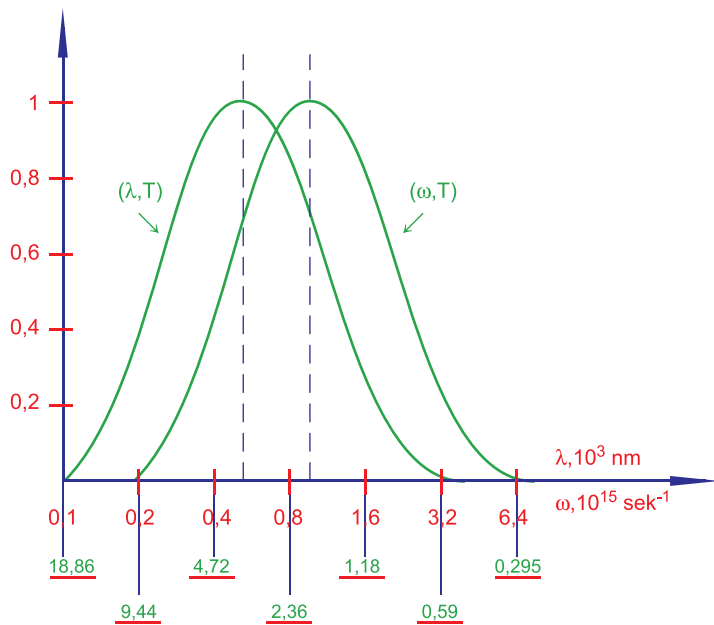
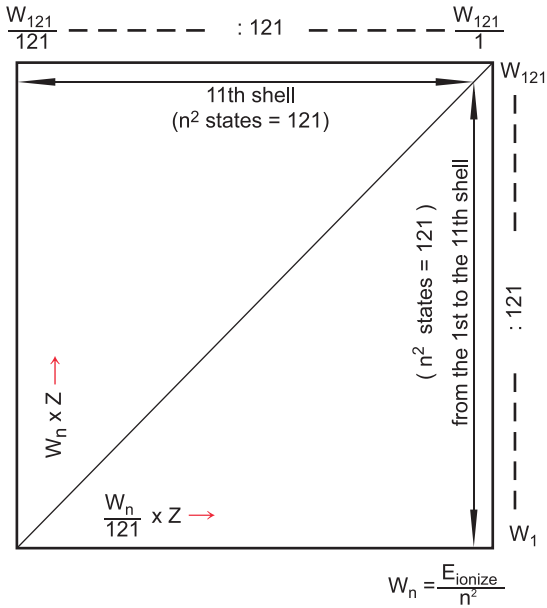

Fig. 6

"Matrix"



$W_1 = E_{\text{ionize}}$ - is the first quantum-state within the range from the 1st to the 11th shell;

W_{121} - is the one hundred and twenty first quantum-state within the range from the 1st to the 11th shell;

$\frac{W_{121}}{1}$ - is the first quantum-state on the 11th shell;

$\frac{W_{121}}{121}$ - is the one hundred and twenty first quantum-state on the 11th shell;

n is the number of electron shell (in the "242x242" matrix, there are 58,564 such quantum-states);
"121x121" = 14,641 is the total number of quantum-states.

Fig. 7

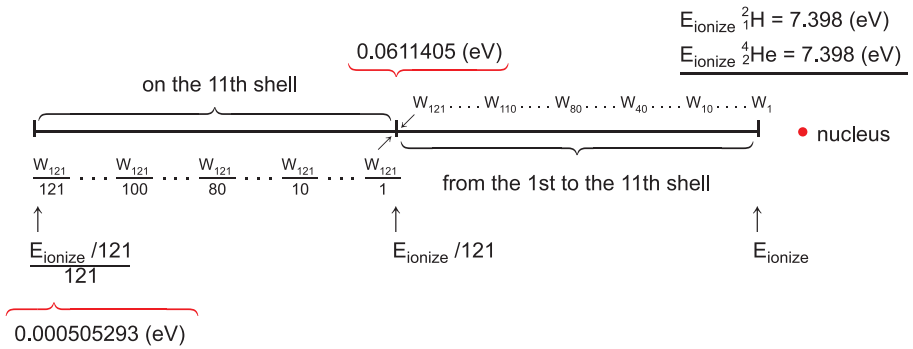

Fig. 8

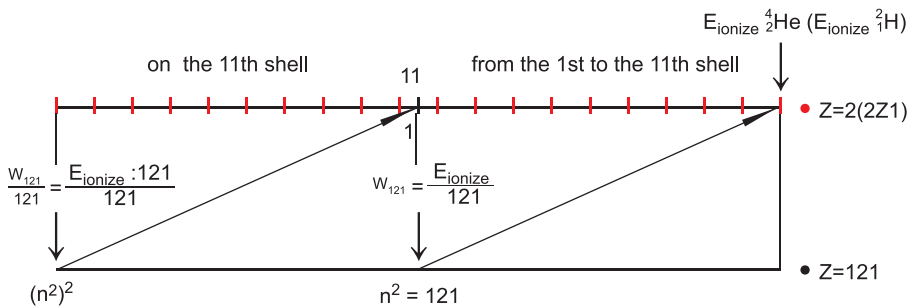

Fig. 9

Graphical explanation to the section:

The relation between electron shells of an atom with nucleus charge Z in respect to the atom electron shells of Deuterium (${}^2_1\text{H}$) and Helium (${}^4_2\text{He}$) . . .

Hydrogen converted into the "121x121" matrix - Helium matrix,

$E_{\text{ionize}} {}^4_2\text{He} = 7.398 \text{ eV}$ is taken for the basis of E_{ionize} .

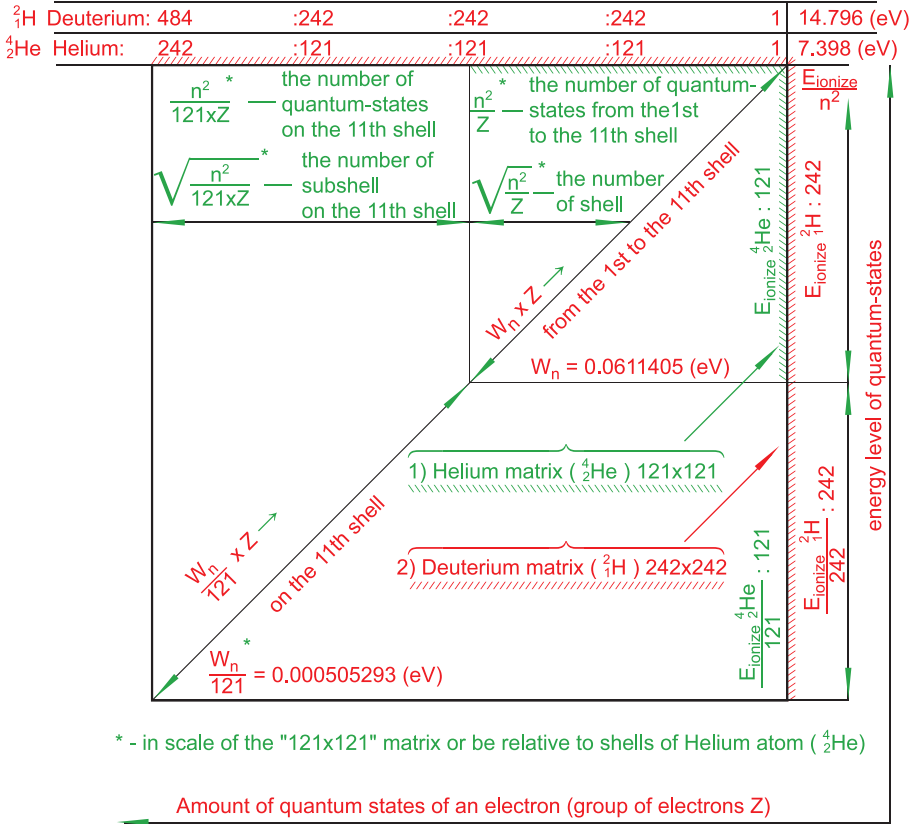

$\frac{2n^2}{242 \times Z}$ on the 11th shell in scale of the "242x242" matrix	$\frac{2n^2}{Z}$ from the 1st to the 11th shell in scale of the "242x242" matrix
--	--

Fig. A

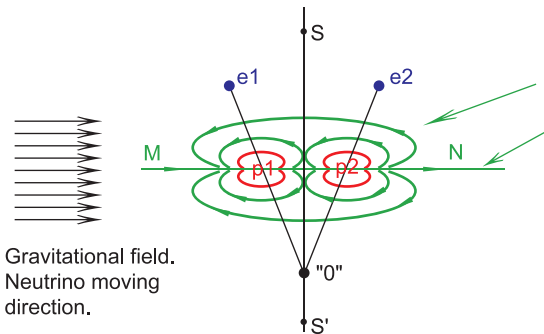

- magnetic field of nucleus (proton p1 and proton p2)
 - the axis of longitudinally coincided poles of proton p1 and proton p2 (axis MN)

p1 - proton 1
 p2 - proton 2
 e1 - electron of the first proton
 e2 - electron of the second proton

"0" - the place of intersection of orbits of electrons e1 and e2 with electrons transition from orbit of one nucleus to an orbit of another (and vice versa) - axis "0S"

Fig. B

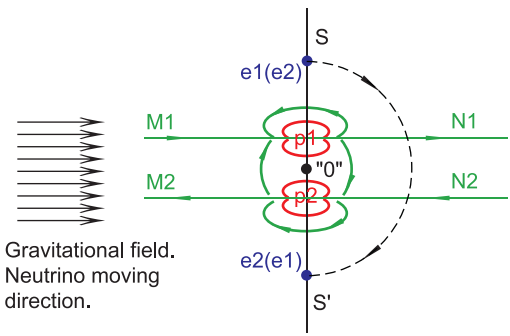

M1N1 - the axis of magnetic poles of proton p1 (along the gravitational field)
 M2N2 - the axis of magnetic poles of proton p2 (towards the gravitational field)

e1(e2) - electron
 e2(e1) - positron
 P1 - proton
 P2 - neutron

Fig. C

①

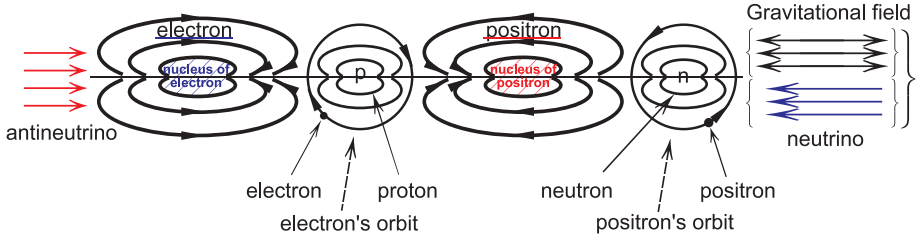

②

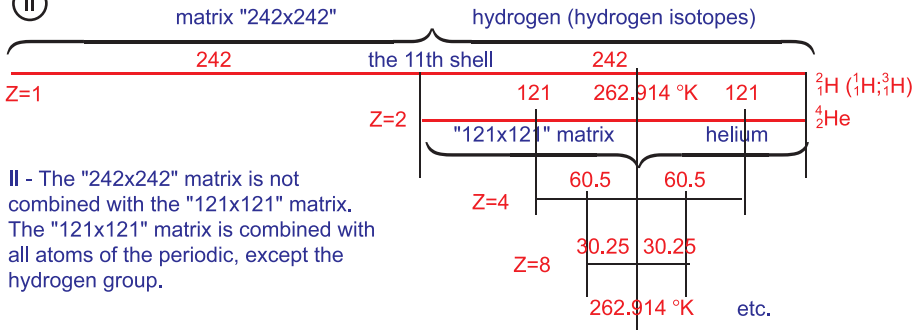

II - The "242x242" matrix is not combined with the "121x121" matrix. The "121x121" matrix is combined with all atoms of the periodic, except the hydrogen group.

③

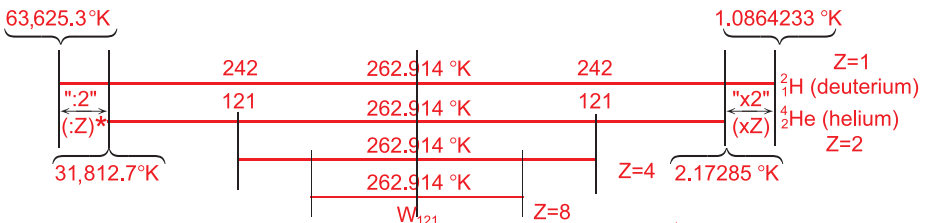

III - The "242x242" matrix (${}^2_1\text{H}$) and the "121x121" matrix (${}^4_2\text{He}$) are combined, or all atoms of the periodic table are combined.

etc. * - see section: "interrelation of electron shells..."

④

A hydrogen group is converted into the "121x121" matrix

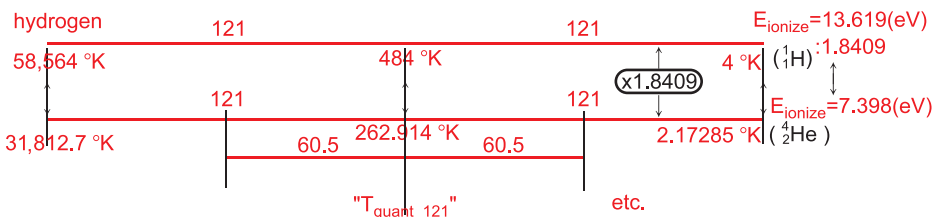

Continuation of fig. C

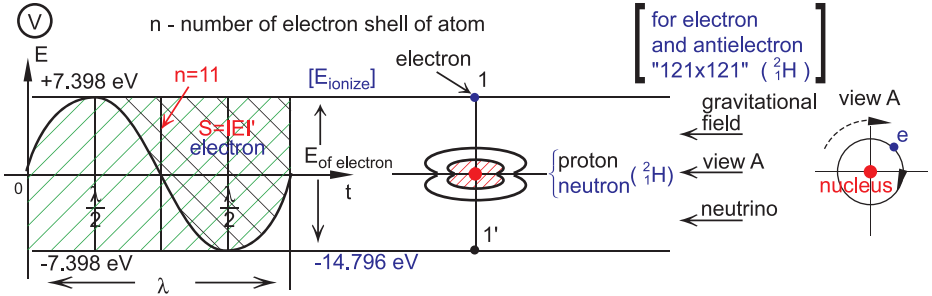

V - Electron is rotating around proton across the gravitational field (axis 1 ÷ 1') the 11th shell (excited state of an atom)

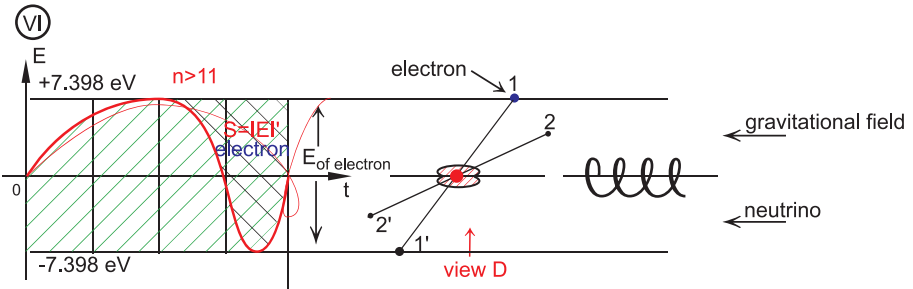

VI - Electron is rotating around proton clockwise (view D); axis 1-1' in an excited state; axis 2-2' - in a strongly excited state (closer to the 11th electron subshell of the 11th shell).

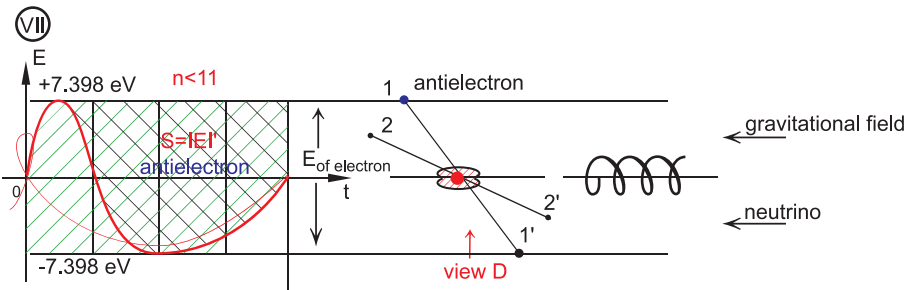

VII - Antielectron is rotating around proton counterclockwise (view D): axis 1-1' in an excited state; axis 2-2' - in a weakly excited state (closer to the 1st electron shell).

It is seen from the figures C-VI, C-VII that an electron while transiting into more excited state, aims at the zone of more negative temperatures, low frequencies. At the same time antielectron in more excited state aims at the zone of more positive temperatures and high frequencies.

Note: S - impulse square (half-wave)
|E|' - electron potential absolute value

Continuation of fig. C

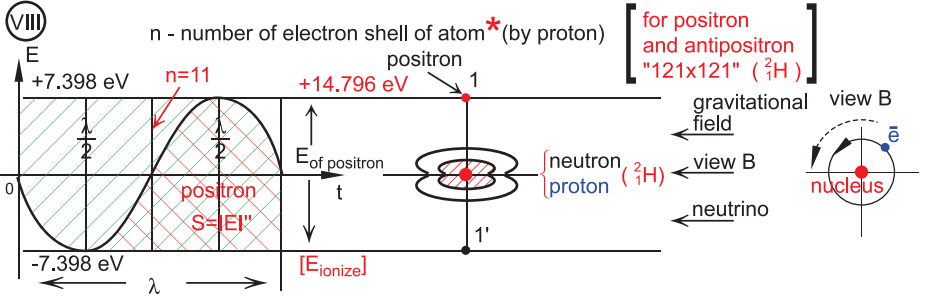

VIII - Positron is rotating around neutron across the gravitational field (axis 1-1') the 11th shell (excited state of an atom)

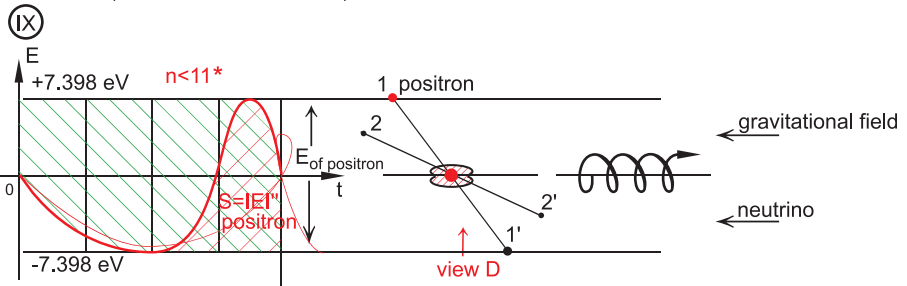

IX - Positron is rotating around neutron clockwise (view D): axis 1-1' in an excited state; axis 2-2' - in a strongly excited state (closer to the 1st electron shell).

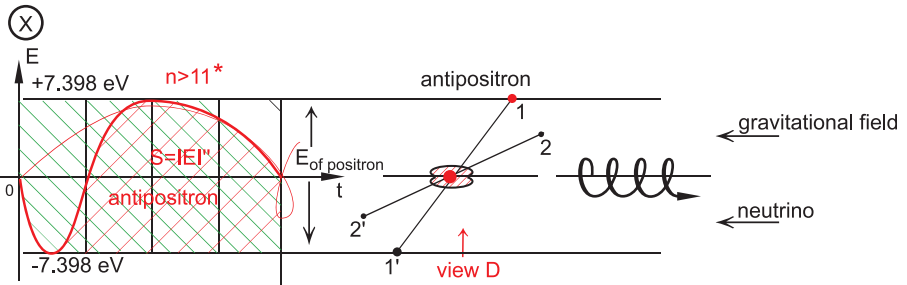

X - Antipositron is rotating around neutron counterclockwise (antipositron) (view D): axis 1-1' in an excited state; axis 2-2' - in a weakly excited state (closer to the 11th electron subshell of the 11th shell).

It is seen from the figures C-IX, C-X that positron transiting into more excited state, aims at the zone of more negative temperatures, low frequencies. At the same time antipositron in more excited state aims at the zone of more positive temperatures and high frequencies.

Note: S - impulse square (half-wave) |E|'' - positron potential absolute value

* - Shell number of atom is considered to be counted with orienting to hydrogen atom (nucleus - proton). In fact it means that quantum-states and numbers of shells of atoms with proton (1_1p) and neutron (1_0n) nucleus are situated in diametrically directions: $W_{121}({}^1_1p) = \frac{W_{211}({}^1_0n)}{121}$; $W_{121}({}^1_0n) = \frac{W_{211}({}^1_1p)}{121}$; Maximum quantum-state of proton is in the zone of high temperatures (58.564K) but maximum quantum-state of neutron is in the zone of low temperatures (1K).

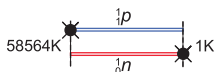

Maximum quantum-state of nucleon; i.e., proton and neutron accordingly, as their quantum-states increase oriented in opposite directions, as was earlier taken in consideration neither in theory nor in practice!

Continuation of fig. C

(XI)

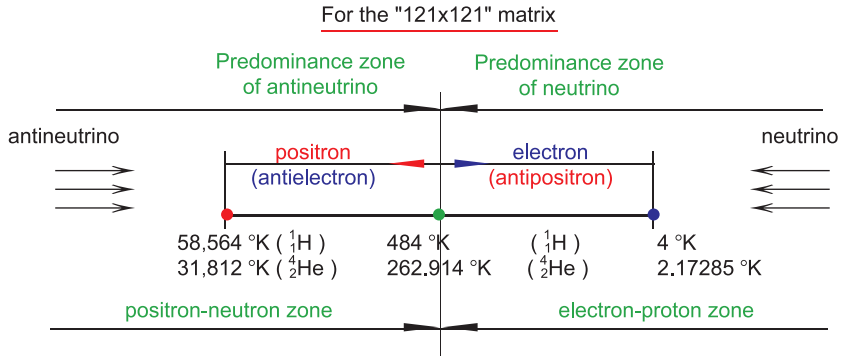

(XII)

Calculation and valuation of the electron energy (E_e) in the matrix "121x121" (^4_2He) & "242x242" (^1_1H):

- "121x121" (^4_2He):
 $E_e = (262.914)^2 \times E_{\text{ionize}}(^4_2\text{He}) = 69.124 \times 7.398 \text{ (eV)} = 511.380 \text{ (eV)} = \underline{0.51138 \text{ (MeV)}}$
- "242x242" (^1_1H):
 $E_e = (262.914)^2 \times E_{\text{ionize}}(^1_1\text{H}) = 69.124 \times 13.619 \text{ (eV)} = 941.400 \text{ (eV)} = \underline{0.9414 \text{ (MeV)}}$

For calculation $E_e(^2_1\text{H})$ & $E_e(^3_1\text{H})$, is taken E_{ionize} of these hydrogen isotopes.

Fig. D

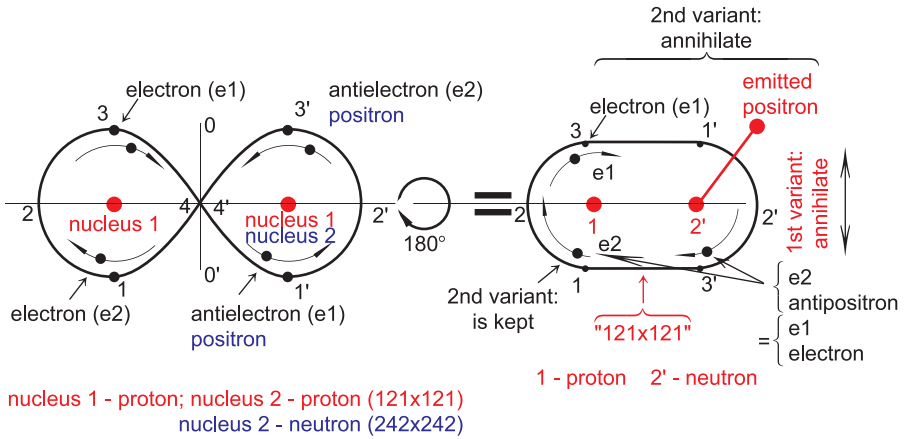

As a rule, a pair fusion (synthesis) of two protons ($2 \cdot {}^1_1p$) with two neutrons ($2 \cdot {}^1_0n$) takes place on the eleventh shell of the "121 x 121" matrix with the following formation of helium atom (4_2He): ${}^2_1H + {}^2_1H = {}^4_2He$.

Fig. E

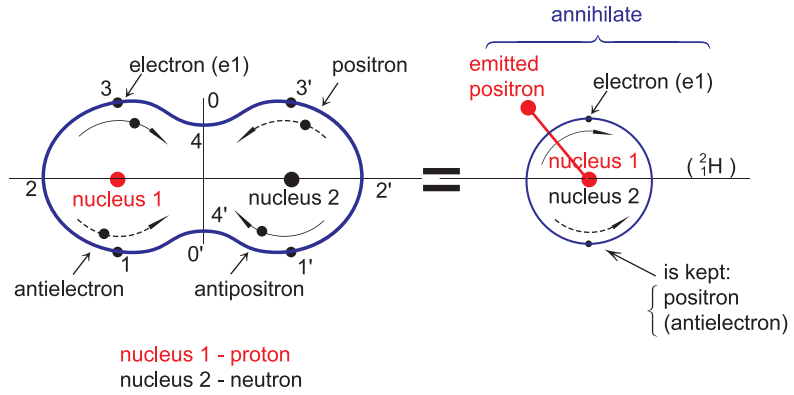

As a rule, deuterium (${}^2_1\text{H}$) is formed on eleventh shell of the "242 x 242" matrix; ${}^2_1\text{H} = {}^1_1\text{p} + {}^1_0\text{n}$.

Fig. 10

Calculation under the formula: $E = 2.32549 \frac{\text{eV}}{\text{degr}} \times 10^{-4} \times \text{C}$

$E = 2.32549 \times 10^{-4} \times \text{C}$

$E = 2.32549 \times 10^{-4} \times (\text{C} + 273)$

E (°C) eV	°C	°K	E (°K) eV
-0.0634859	-273	0	0.000000000
-0.0353474	-152	121	0.0281384
-0.0232549	-100	173	0.0402309
-0.0006976	-3	270	0.0627882
0.0000000	0	273	0.0634859
0.0232549	100	373	0.0867408
0.0490678	211	484	0.1125537
0.1125537	484	757	0.1760396
0.1492965	642	915	0.2127823
0.2144102	922	1 195	0.2778961
0.3148713	1 354	1 627	0.3783572
0.4813764	2 070	2 343	0.5448623
0.7876435	3 387	3 660	0.8511293
1.4497105	6 234	6 507	1.5131963
3.3412640	14 368	14 641	3.4047499
13.5555	58 291	58 564	13.619

$13.619 \text{ (eV)} = 13.5555 \text{ (eV)} + 0.0634859 \text{ (eV)}$

Necessarily so: $F = 562.311 \frac{\text{Hz}}{\text{degr}} \times \text{C}; F = 562.311 \frac{\text{Hz}}{\text{degr}} \times (\text{C} + 273)$.

Having made a Celsius degree the basic unit of calculation, we have taken into account that negative temperatures have a negative energy level of ionization. As a result, within the range between 0 °C and -273 °C, E varies from 0.000000000 to -0.0634859 eV, while within the range between 0 °C to 58,291 °C, E varies from 0.000000000 to 13.5555 eV.

as a whole: $E = |-E| + |E| = 13.619 \text{ eV}$ $| -E_{\text{max}} | = 0.0634859 \text{ eV}$
 $| +E_{\text{max}} | = 13.55555 \text{ eV}$

Then $E(\text{°C}) = 2.32549 \times 10^{-4} \times \text{C}; E(\text{°K}) = 2.32549 \times 10^{-4} \times (\text{C} + 273)$.

Fig. 11

Relation of temperatures in degrees of Celsius and Kelvin within the range of temperatures from 58,564 to 4 °K or E_{ionize} from 13.5555 eV [58,291 °C] to 0.112029 eV [481.74 °C] and from 0.112029 eV [481,74 °C] to 0.000925859 eV [3.98 °C]

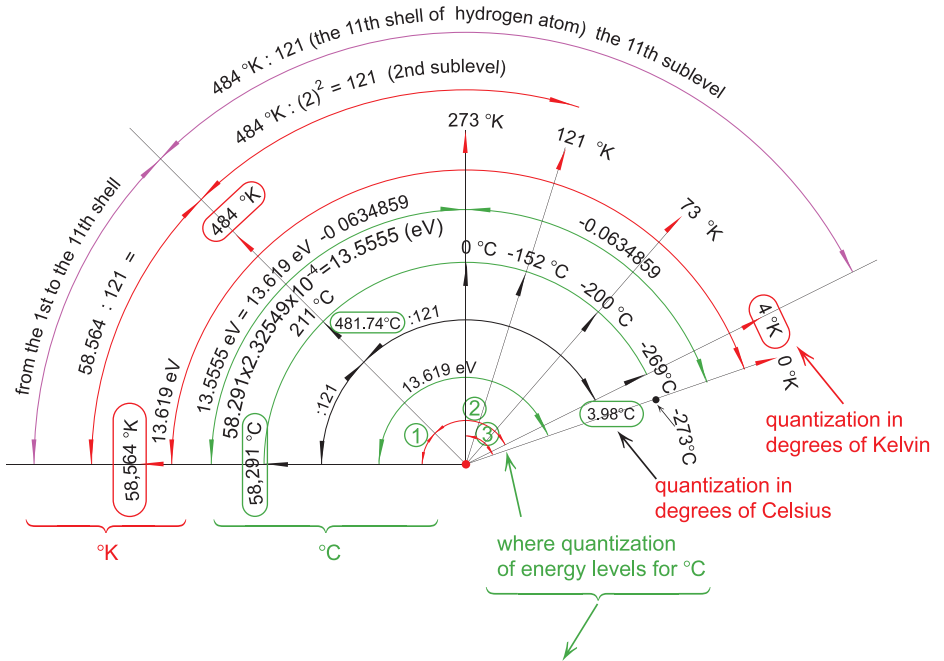

- 1 corresponds to energy level from 58.291 to 481.74 °C, or from 13.5555 to 0.112029 eV;
- 2 corresponds to energy level from 481.74 to 3.98 °C, or from 0.112029 to 0.000925859 eV;
- 3 corresponds to energy level from 0 to -273 °C, or from 0.000000 to -0.0634859 eV.

°C: $E = 2.32549 \times 10^{-4} \frac{\text{eV}}{\text{degr}} \times \text{ }^\circ\text{C}$; where $\text{ }^\circ\text{C} = (+\text{ }^\circ\text{C} \div -\text{ }^\circ\text{C})$.

°K: $E = 2.32549 \times 10^{-4} \frac{\text{eV}}{\text{degr}} \times (\text{ }^\circ\text{C} + 273)$; where $(\text{ }^\circ\text{C} + 273) = \text{ }^\circ\text{K}$.

Fig. 12

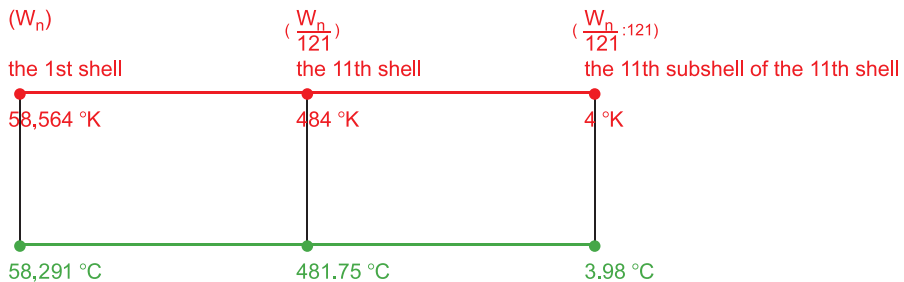

- - temperature quantization on electron shells of hydrogen atom (${}^1_1\text{H}$) on scale of Kelvin degrees
- - temperature quantization on electron shells of hydrogen atom (${}^1_1\text{H}$) on scale of Celsius degrees

Fig. 13

Temperature in °C is taken for the basis.
 The hydrogen matrix (${}^1_1\text{H}$) will look like:

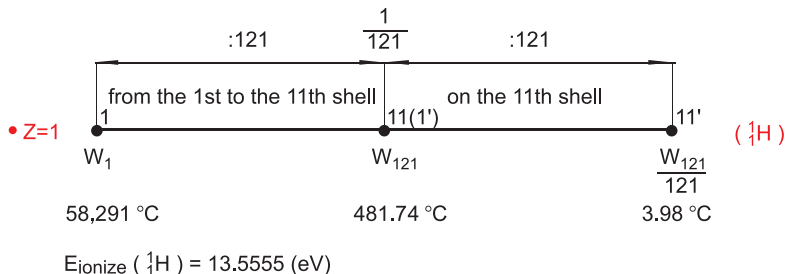

Fig. 14

The carbon matrix (${}^{12}_6\text{C}$) brought into the "single coordinates" will look like:

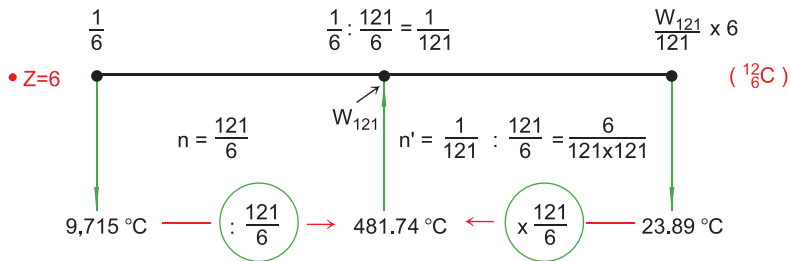
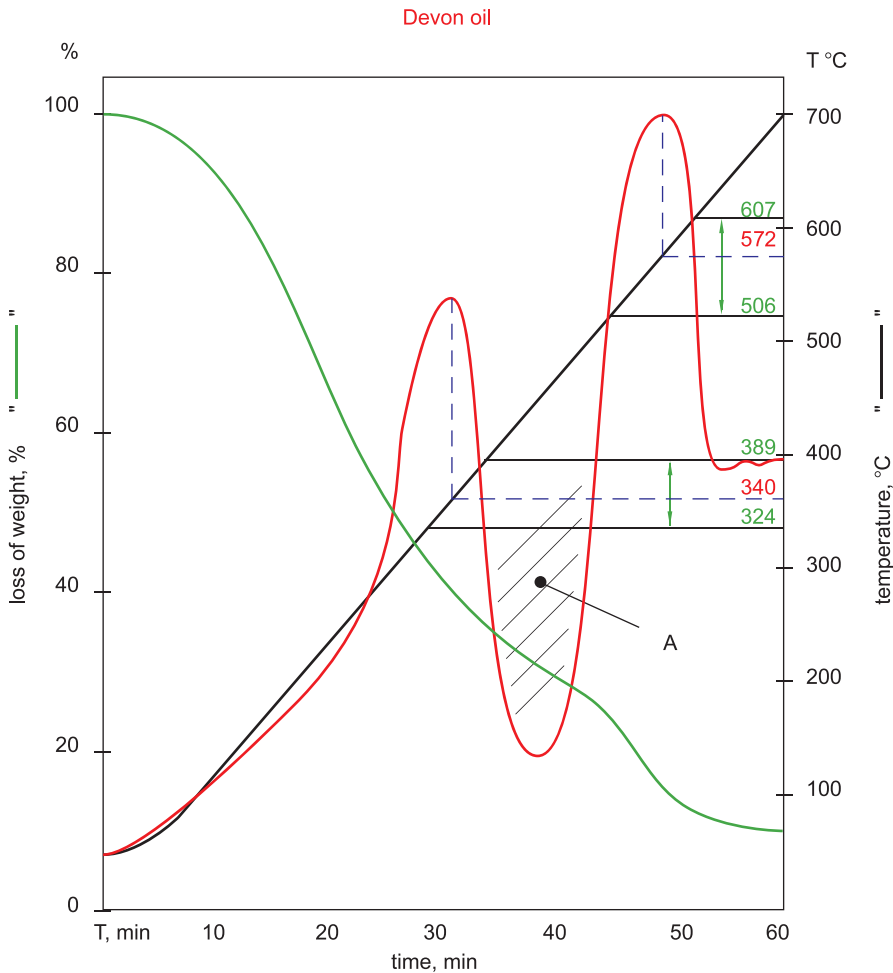

Fig. 15

Annex to the calculation of "C-H" compositions resonant temperatures for hydrocarbon mixture (for oil)

- " — " - loss of weight (%)
- " — " - changes of temperature (°C)
- " — " - reaction of oil
- "A" - endothermic effect area



Devon oil is very light, therefore its lower resonant temperatures range is moved to the left (closed to zero) to a greater extent than in case with another heavier oils.

Fig. 16

Diagram of excitations of hydrocarbon liquid (oil) in the stock container produced through excitation of hydrogen.

When acting upon the hydrocarbon mixture through hydrogen (^1H) - his resonant frequency:

$$F_{\text{res}} = (153,510 + 210^\circ \times 562.311) \times 10^8 \text{ (Hz)}$$

we have not zone A but zone B

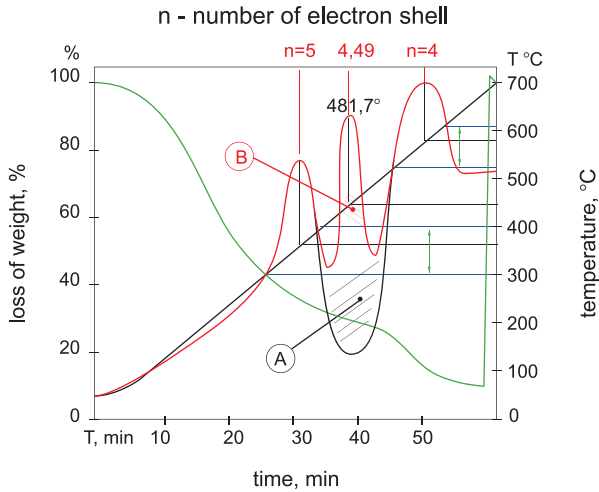

B - i.e., the zone of exothermal effect arising in the hydrocarbon mixture after the latter has been affected through hydrogen ^1H ;

A - the zone of endothermic effect, which is constantly present in the unexcited mixture or cracking oil zone.

Fig. 17

^1_1H in the "121x121" matrix

A diagram illustrating conversion of one energy type into another (quantization) at each of the eleventh levels (electron shell).

011: zone of transition of a matter in energy ($t^{\circ}\text{C} = +211/-269$)

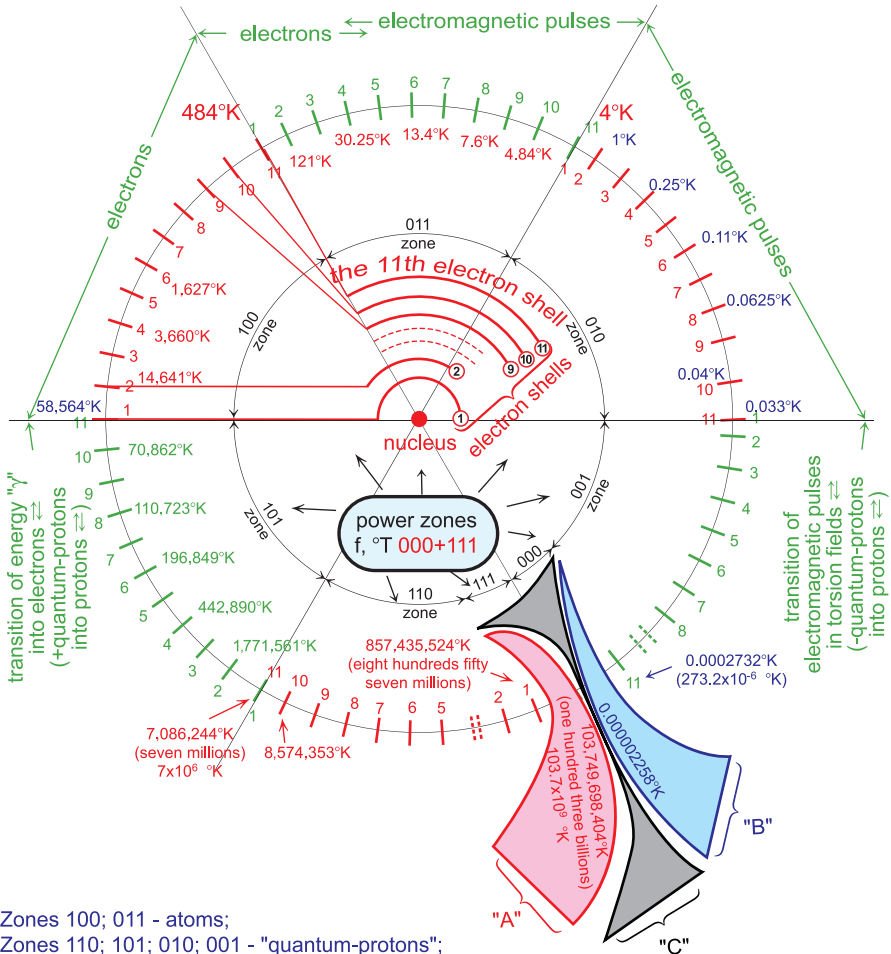

Zones 100; 011 - atoms;
 Zones 110; 101; 010; 001 - "quantum-protons";
 Zones 000 and 111 are zones of "black holes" formation.

"A" - zone of an extremely high frequency of radiated energy, high density;

"B" - superhigh frequencies, deep vacuum;

"C" - formation of "black holes" - meeting (colliding), two types of energy A and B collapse, i.e. are compressed with power and speed sufficient for a "black hole" to be formed.

It is quite possible that the quantum-state 273.2×10^{-6} °K in the "121x121" matrix (or one quantum-state 17.075×10^{-6} °K in the "242x242" matrix) is in fact the so-called neutrino (antineutrino).

Nikolay Shlyakhtin

Printed in LLC "Printer", 7, Lugovaya str., Russia,
Yaroslavl reg., Rybinsk
order № 1128, edition 100 copies.

Format 62x84/16, offset paper,
offset printing,
typeface Times New Roman.



Nikolay Shlyakhtin

Fig. 13

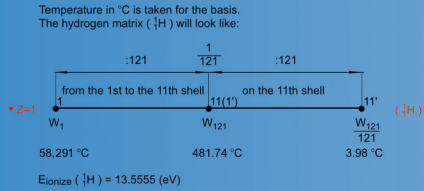
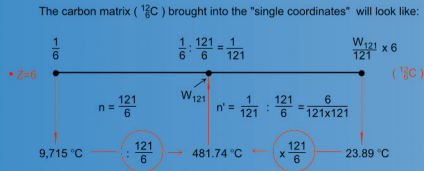

Fig. 14



New in quantum physics

...For all of us it is time to turn to the real science – to knowledge sources. In fact it is not casual that gravitation and large-scale structure of the Universe do not consider quantum-mechanical uncertainty principle up to now. «The God does not play with bones» – if not all but the majority of scientists really understand these Einstein's words which became classics.